

DRAWING INDEX

CONNECTOR LOADING DIAGRAMS.....3-4-5-6-7-8
 CONNECTOR LOCATING DIAGRAM.....9
 POWER DISTRIBUTION.....10-11
 GROUND DISTRIBUTION.....12
 SWITCHES.....14-15
 WIPER SYSTEM.....16
 FORWARD LAMP WIRING.....17
 REAR LIGHT WIRING-STANDARD.....18-19
 CLEARANCE LIGHT SYSTEM.....20
 FRONT CLEARANCE LIGHT.....21
 REAR CLEARANCE LIGHT.....22
 PANEL LAMP.....23
 DOOR AJAR.....24

WIRE COLOR CODE:

- BK - BLACK
- BR - BROWN
- DB - DARK BLUE
- DG - DARK GREEN
- GY - GRAY
- LB - LIGHT BLUE
- LG - LIGHT GREEN
- OR - ORANGE
- PK - PINK
- RD - RED
- YL - YELLOW
- VT - VIOLET
- WT - WHITE

WIRE GAUGE CHART:

- 18 - 18 GA - 0.8mm
- 16 - 16 GA - 1.0mm
- 14 - 14 GA - 2.0mm
- 12 - 12 GA - 3.0mm

NOTES:

- 1) ALL CONNECTORS ARE SHOWN IN THE LOAD POSITION.
- 2) SPECIAL CUSTOMER OPTIONS MAY NOT BE COVERED BY THESE DIAGRAMS.

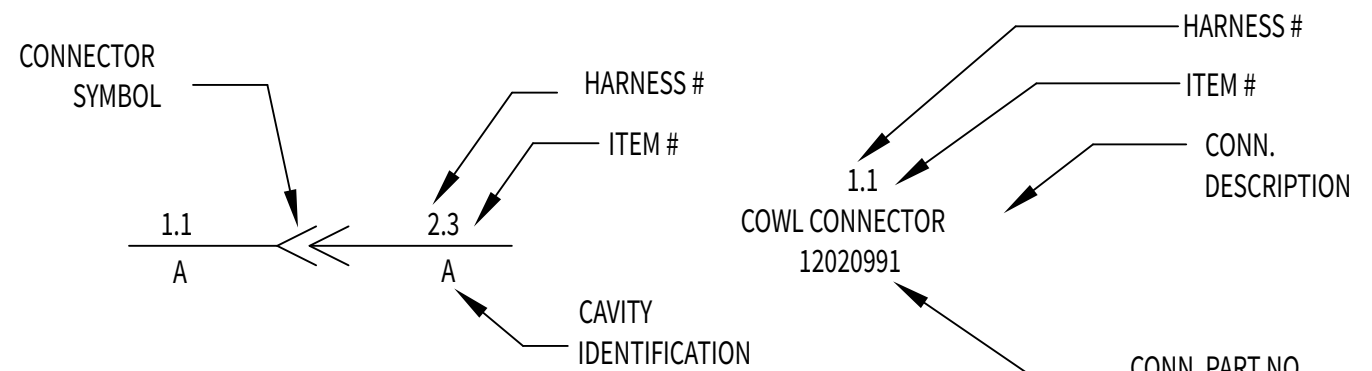

CONTINUE TO ANOTHER SHEET

CONTINUED FROM ANOTHER SHEET

CONN. WITH NO NUMBER ASSIGNED

SPLICE

1 - HARNESS #

500 BK 2.0mm

WIRE GAUGE SIZE IN MM

WIRE COLOR

CIRCUIT #

LEGEND

- BATT HOT AT ALL TIMES
- IGN HOT IN RUN OR START
- ACC HOT IN ACC OR RUN

| | | | | | | | | | | | | |
|--------------|--------------------------|--|--|--|--|----------|----------|-------------------------------------------------------------------|--------------------------------|-----------|-------------|---|
| PAGE 2 OF 12 | REVISIONS | | | | | ENGINEER | DRAWN BY | Spartan Motors USA, Inc. 603 Earthway Blvd Bristol, N 46507 | | TITLE | | |
| | A RELEASE FOR PRODUCTION | | | | | 515140 | --- | JYD | SCHEMATIC FREIGHTLINER MT45 | | | |
| REV. | A | | | | | AUTH | DATE | CHECKED BY | APPROVED BY | CAGE CODE | DWG. NUMBER | |
| | | | | | | | 02/17/17 | RLC | | 36MVO | 58232644 | A |

CONNECTOR VIEW

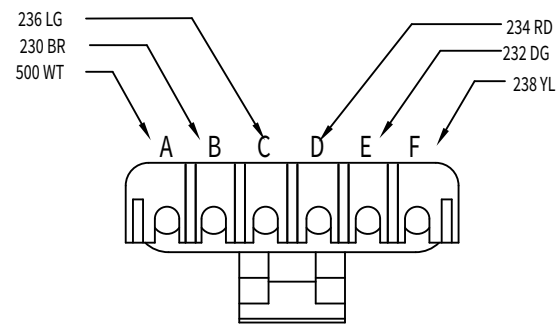

1.1
TO REAR STRUCTURE HARNESS
12015799

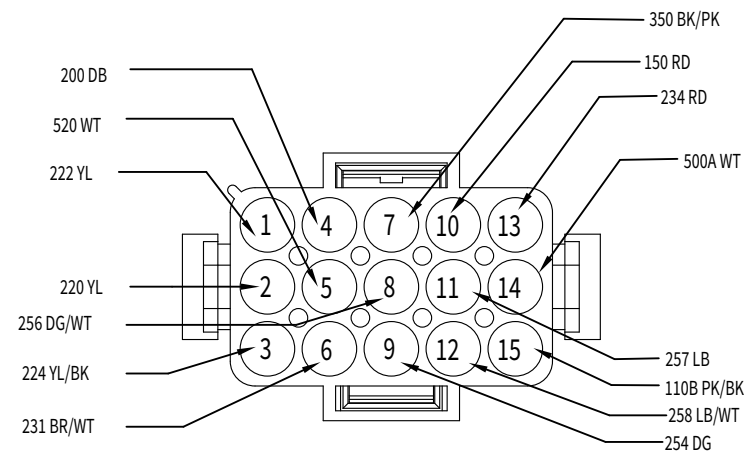

2.1
TO ROOF HARNESS
770023-1

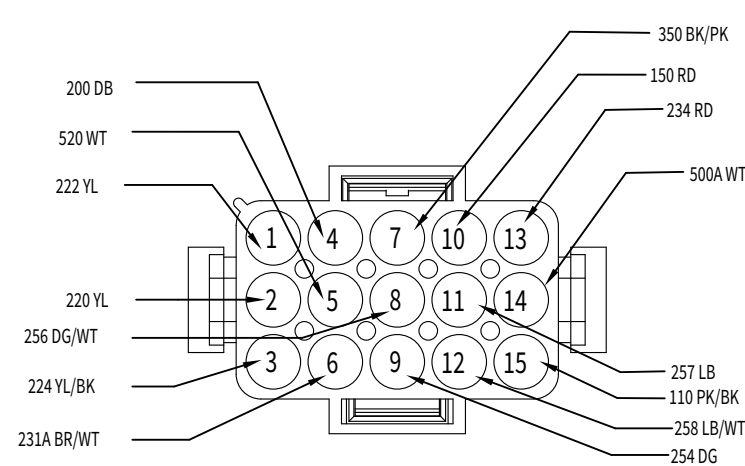

2.2
TO ROOF HARNESS
770023-1

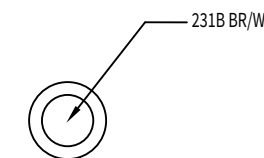

2.3
"A" PILLAR(ROOF)
MOLDED CONN.

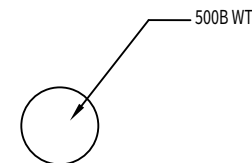

2.4
"A" PILLAR(ROOF)
MOLDED CONN.

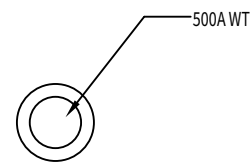

3.1
"A" PILLAR(ROOF)
MOLDED CONN.

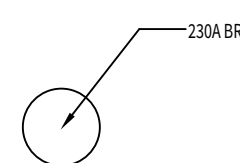

3.2
"A" PILLAR(ROOF)
MOLDED CONN.

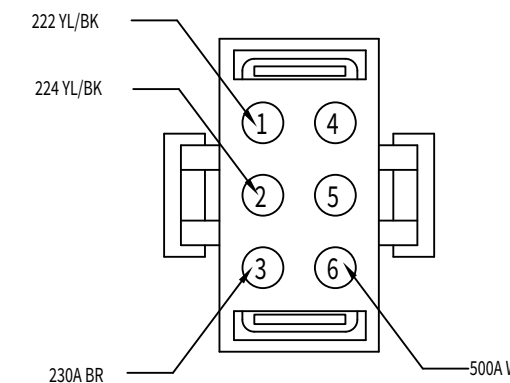

4.4
ROOF HARNESS
770020-1

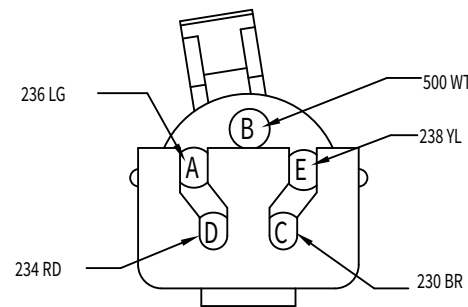

5.1
LEFT S/T/T FEED
12034342

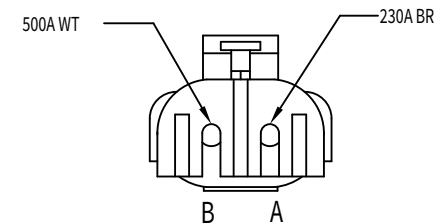

5.2
LEFT MARKER
12015792

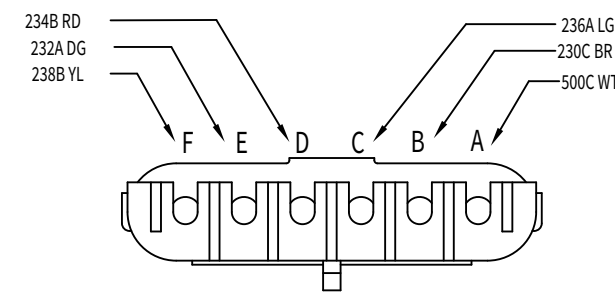

5.4
FRAME RAIL HARNESS
12010975

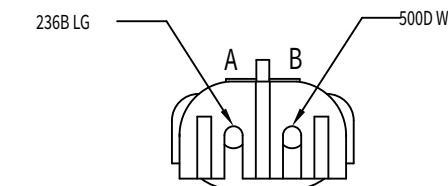

5.5
BACK UP ALARM
12010973

LEGEND

| | |
|------|---------------------|
| BATT | HOT AT ALL TIMES |
| IGN | HOT IN RUN OR START |
| ACC | HOT IN ACC OR RUN |

| | | | | | | | | | | | |
|--------------------------|--|--|--|--------|------|----|-------------|----------|----------|-------------------------------------------------------------------|-------------------|
| A RELEASE FOR PRODUCTION | | | | 515140 | | | | ENGINEER | DRAWN BY | Spartan Motors USA, Inc. 603 Earthway Blvd Bristol, N 46507 | TITLE |
| REVISIONS | | | | AUTH | DATE | BY | CHECKED BY | --- | JYD | | SCHEMATIC |
| | | | | | | | RLC | | | | FREIGHTLINER MT45 |
| | | | | | | | APPROVED BY | | DATE | CAGE CODE | DWG. NUMBER |
| | | | | | | | | | 02/17/17 | 36MVO | 58232644 |
| | | | | | | | | | | DOCUMENT IS ELECTRONICALLY CONTROLLED. VERIFY REV PRIOR TO USE. | A |

CONNECTOR VIEW

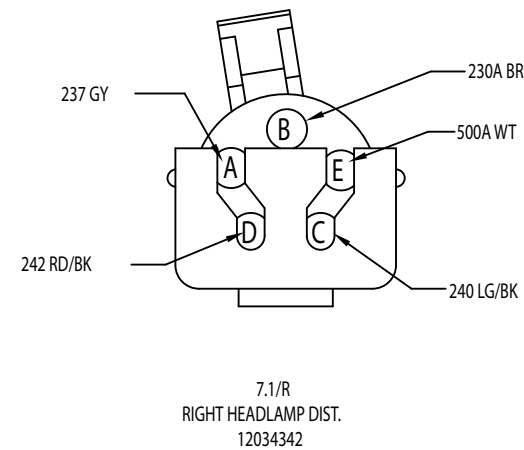
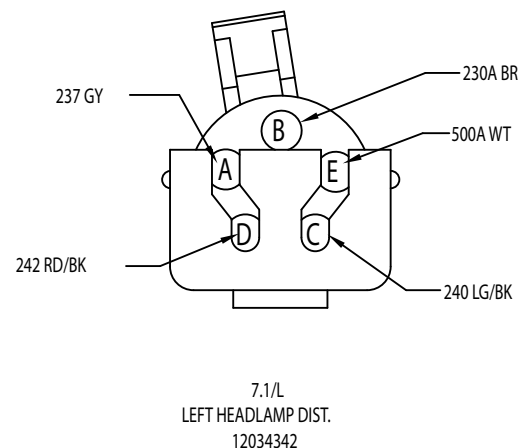
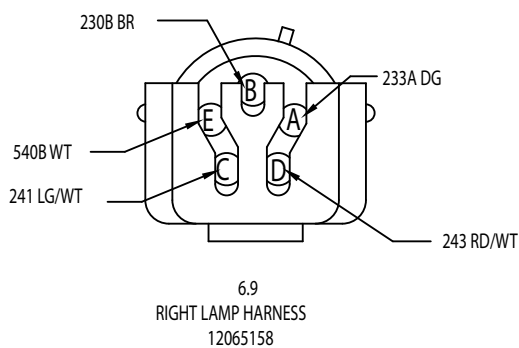
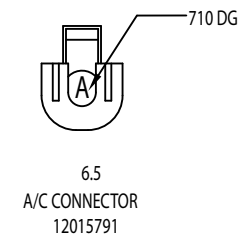
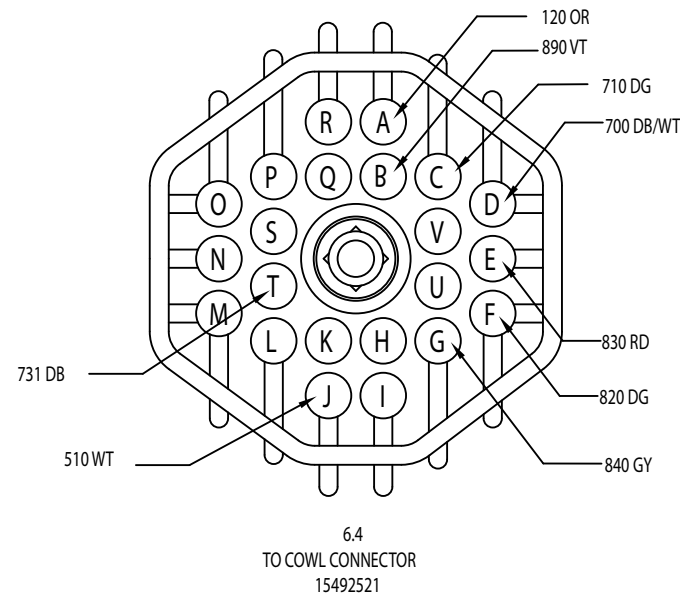
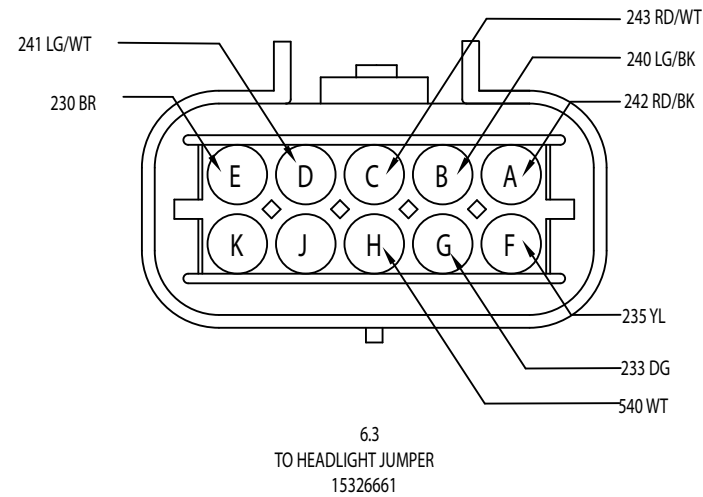
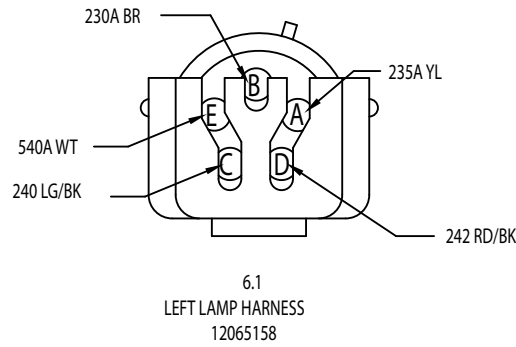
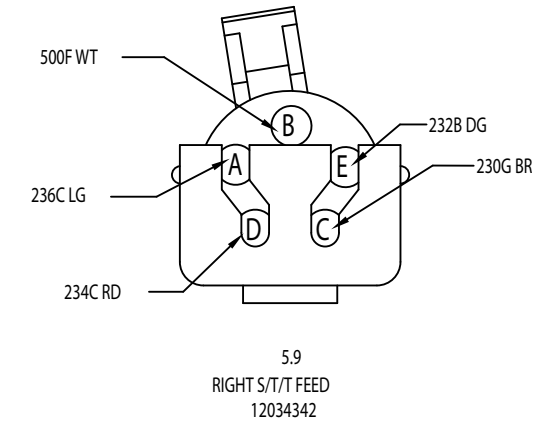
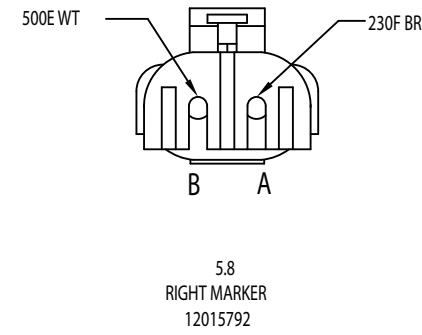
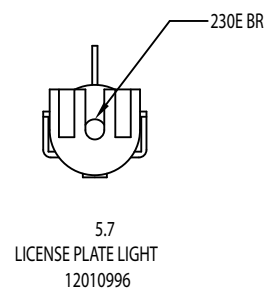
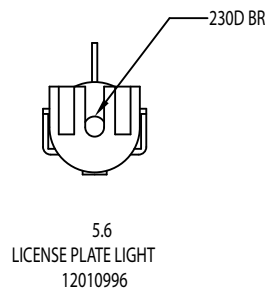

| LEGEND | |
|--------|---------------------|
| | HOT AT ALL TIMES |
| | HOT IN RUN OR START |
| | HOT IN ACC OR RUN |

PAGE 4 OF 12

| | | | | | | | | | | | | | | | | | | |
|--------------------------------------|-----------|--|--|--|--------|------|----|------------|-------------|----------|----------|-------------------------------------------------------------------|----------|----------------------------------------|-------|------------|----------|---|
| <p>RELEASE FOR PRODUCTION</p> | | | | | 515140 | | | | | ENGINEER | DRAWN BY | Spartan Motors USA, Inc. 603 Earthway Blvd Bristol, N 46507 | TITLE | SCHEMATIC FREIGHTLINER MT45 | | | | |
| REV. | REVISIONS | | | | AUTH | DATE | BY | CHECKED BY | APPROVED BY | RLC | RLC | DATE | 02/17/17 | CAGE CODE | 36MV0 | DWG NUMBER | 58232644 | A |

THE INFORMATION CONTAINED IN THIS DRAWING IS THE SOLE PROPERTY OF SPARTAN MOTORS USA, INC. ANY REPRODUCTION IN PART OR AS A WHOLE WITHOUT THE WRITTEN PERMISSION OF SPARTAN MOTORS USA, INC. IS PROHIBITED. DOCUMENT IS ELECTRONICALLY CONTROLLED. VERIFY REV PRIOR TO USE.

CONNECTOR VIEW

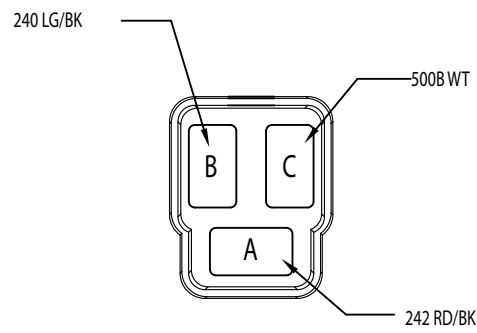

7.6/L
LEFT HEADLIGHT
12077384

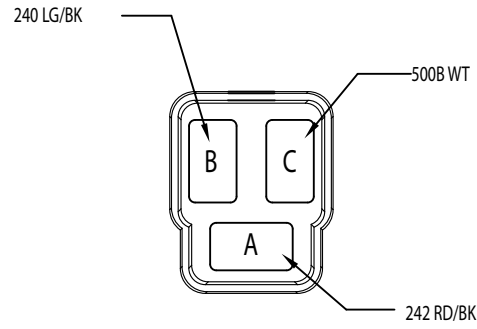

7.6/R
RIGHT HEADLIGHT
12077384

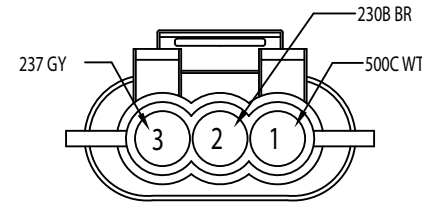

7.8/L
LEFT TURN/MARKER LIGHT
282087-1

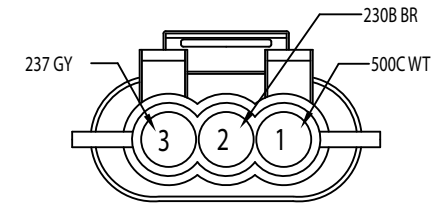

7.8/R
RIGHT TURN/MARKER LIGHT
282087-1

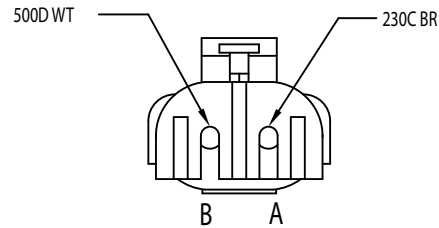

7.9/L
LEFT SIDE MARKER LIGHT
12015792

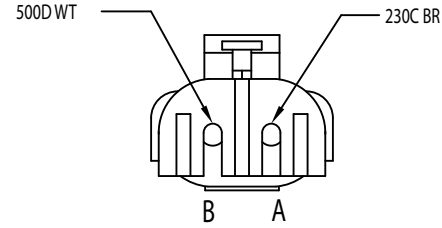

7.9/R
RIGHT SIDE MARKER LIGHT
12015792

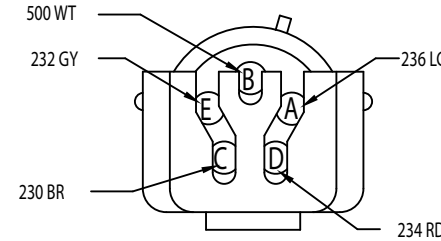

8.1/L
LEFT S/T/T DIST.
12065158

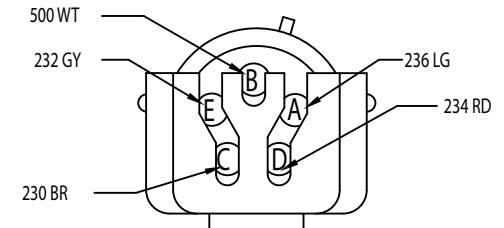

8.1/R
RIGHT S/T/T DIST.
12065158

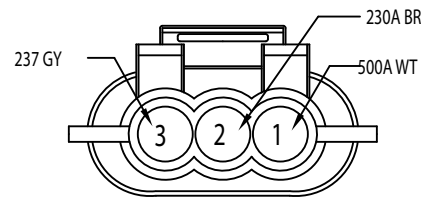

8.2/L
LEFT STOP/TAILO
282087-1

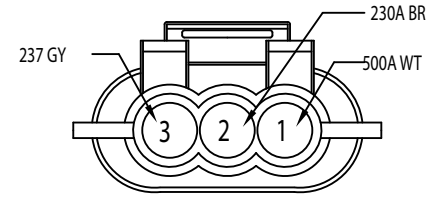

8.2/R
RIGHT STOP/TAILO
282087-1

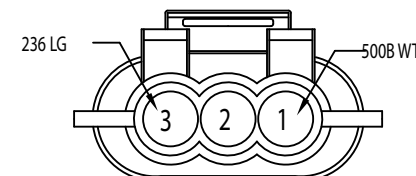

8.3/L
LEFT BACK-UP
282087-1

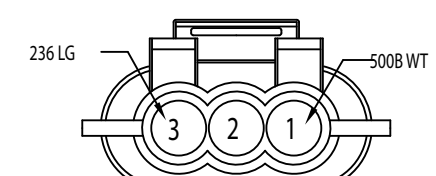

8.3/R
RIGHT BACK-UP
282087-1

| LEGEND | |
|--------|---------------------|
| | HOT AT ALL TIMES |
| | HOT IN RUN OR START |
| | HOT IN ACC OR RUN |

PAGE 5 OF 12

| | | | | | | | | | | | | | | |
|--------------------------------------|-----------|------|------|----|------------|-------------|-----|-----|-----|------------|----------|-------------------------------------------------------------------|------------|----------------------------------------|
| <p>RELEASE FOR PRODUCTION</p> | | | | | 515140 | | | | | ENGINEER | DRAWN BY | Spartan Motors USA, Inc. 603 Earthway Blvd Bristol, N 46507 | TITLE | SCHEMATIC FREIGHTLINER MT45 |
| REV. | REVISIONS | AUTH | DATE | BY | CHECKED BY | APPROVED BY | RLC | RLC | RLC | CHECKED BY | DATE | CAGE CODE | DWG NUMBER | |
| | | | | | | | | | | | 02/17/17 | 36MV0 | 58232644 | A |

THE INFORMATION CONTAINED IN THIS DRAWING IS THE SOLE PROPERTY OF SPARTAN MOTORS USA, INC. ANY REPRODUCTION IN PART OR AS A WHOLE WITHOUT THE WRITTEN PERMISSION OF SPARTAN MOTORS IS PROHIBITED. DOCUMENT IS ELECTRONICALLY CONTROLLED. VERIFY REV PRIOR TO USE.

CONNECTOR VIEW

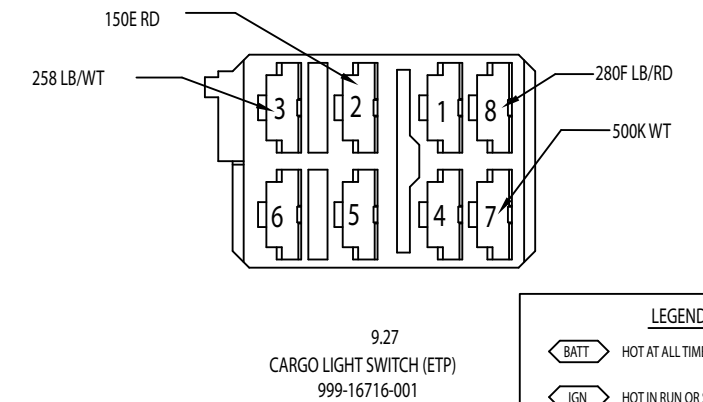
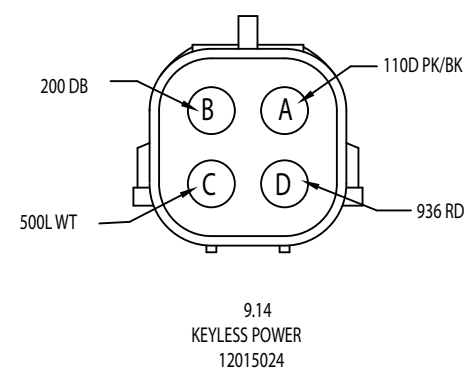
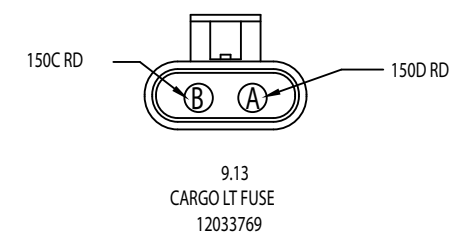
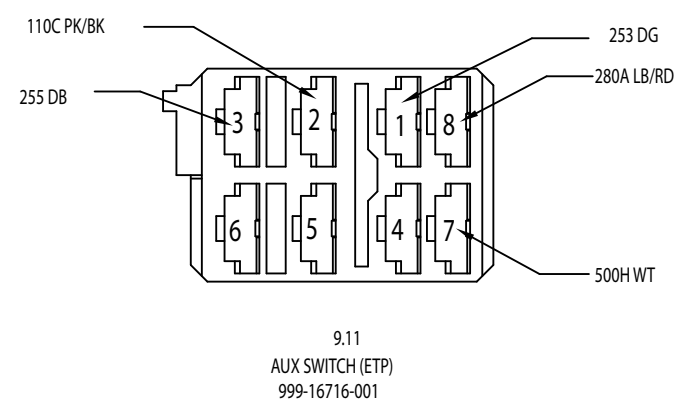
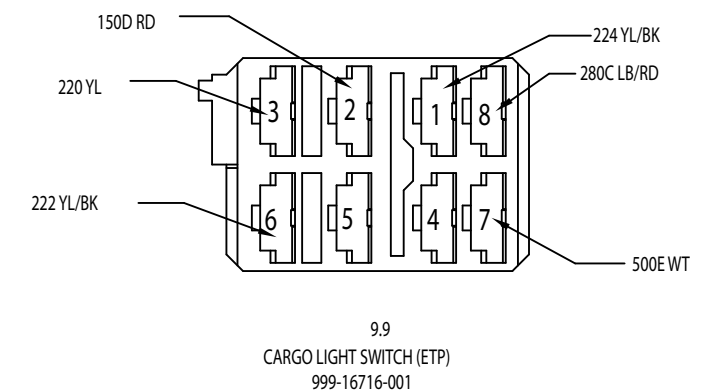
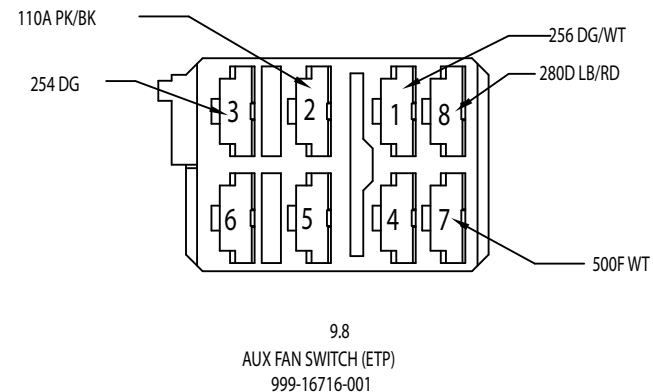
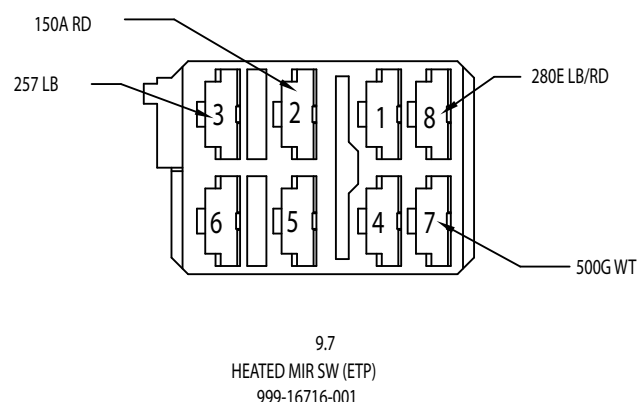
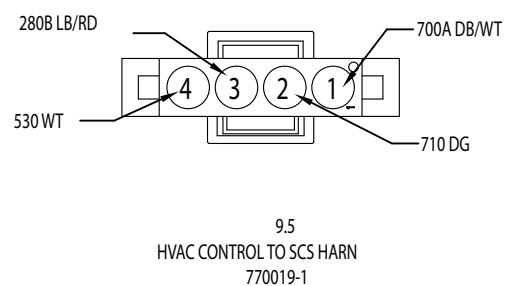
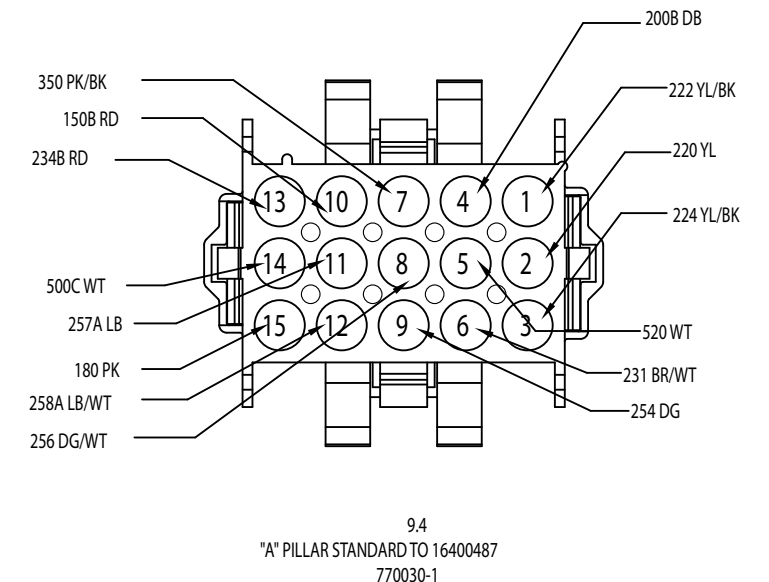
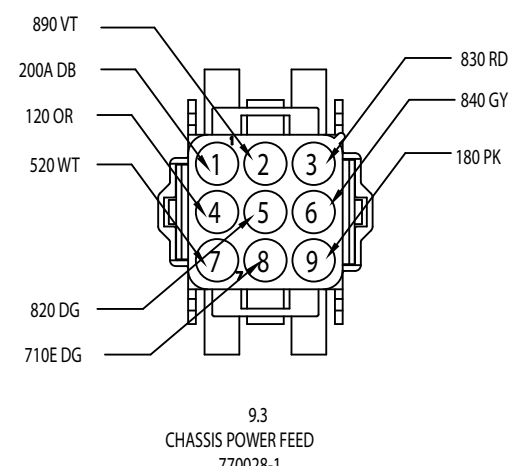
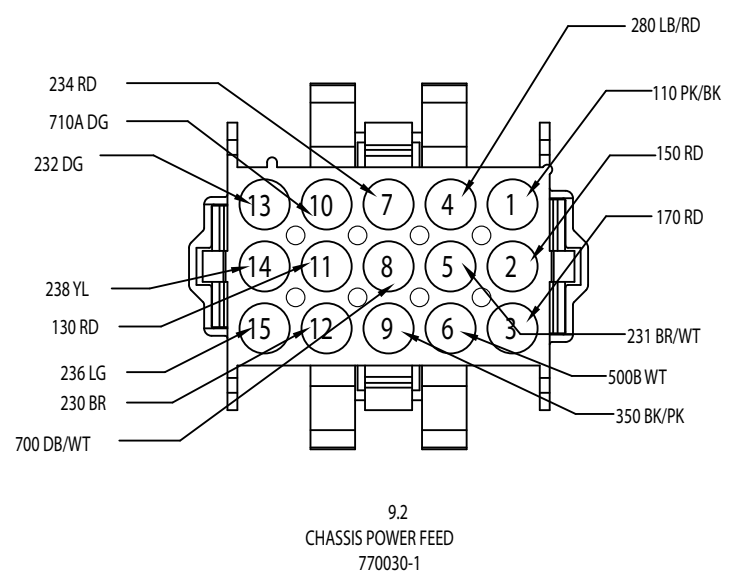
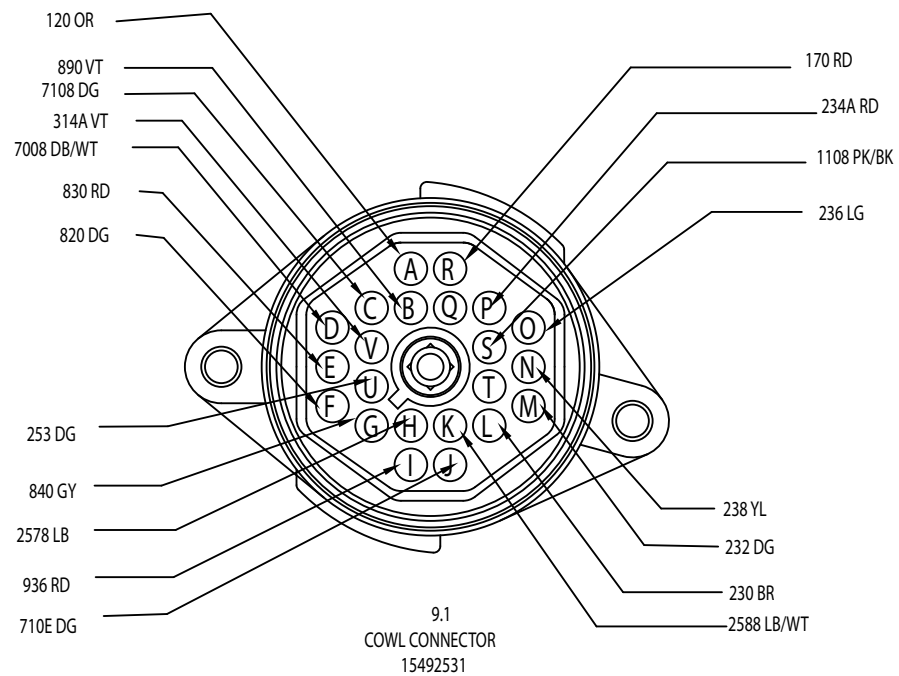

LEGEND

| | |
|------|---------------------|
| BATT | HOT AT ALL TIMES |
| IGN | HOT IN RUN OR START |
| ACC | HOT IN ACC OR RUN |

PAGE 6 OF 12

| | | | |
|------|--|------------------------|--|
| A | | RELEASE FOR PRODUCTION | |
| REV. | | REVISIONS | |

| | | | | | | |
|--------|------|----|------------|-------------|--|--|
| 515140 | | | | | | |
| AUTH | DATE | BY | CHECKED BY | APPROVED BY | | |

| | | | |
|------------|-----|----------|----------|
| ENGINEER | --- | DRAWN BY | JYD |
| CHECKED BY | RLC | DATE | 02/17/17 |

| | | | |
|-------------------------------------------------------------------|--|------------|----------|
| Spartan Motors USA, Inc. 603 Earthway Blvd Bristol, N 46507 | | TITLE | SCHMATIC |
| CAGE CODE | | DWG NUMBER | 58232644 |

| | | | |
|-------------------------------------------------------------------|--|------------|----------|
| Spartan Motors USA, Inc. 603 Earthway Blvd Bristol, N 46507 | | TITLE | SCHMATIC |
| CAGE CODE | | DWG NUMBER | 58232644 |

THE INFORMATION CONTAINED IN THIS DRAWING IS THE SOLE PROPERTY OF SPARTAN MOTORS USA, INC. ANY RE PRODUCTION IN PART OR AS A WHOLE WITHOUT THE WRITTEN PERMISSION OF SPARTAN MOTORS USA, INC. IS PROHIBITED. DOCUMENT IS ELECTRONICALLY CONTROLLED. VERIFY REV PRIOR TO USE.

CONNECTOR VIEW

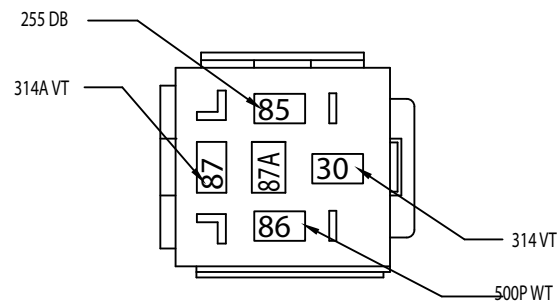

9.28
AUX HEATER RELAY
12033871

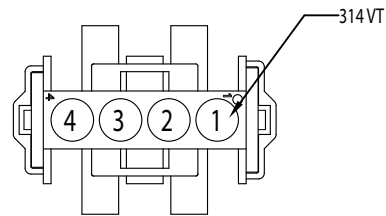

9.29
AUX HEATER FEED
770026-1

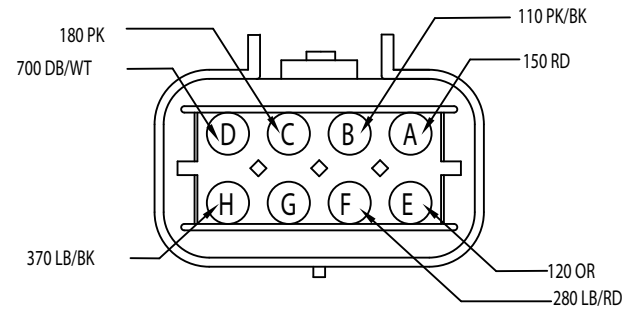

10.1
BODY BUILDER CONNECTOR
15326655

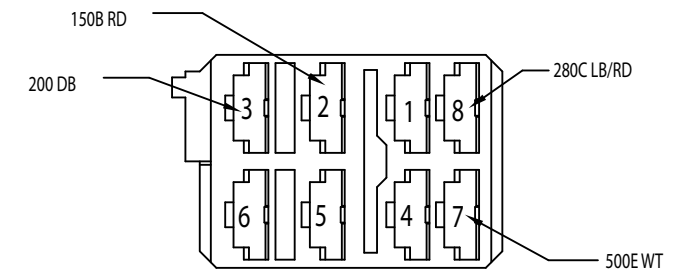

10.2
DOME LIGHT SWITCH (ETP)
999-16716-001

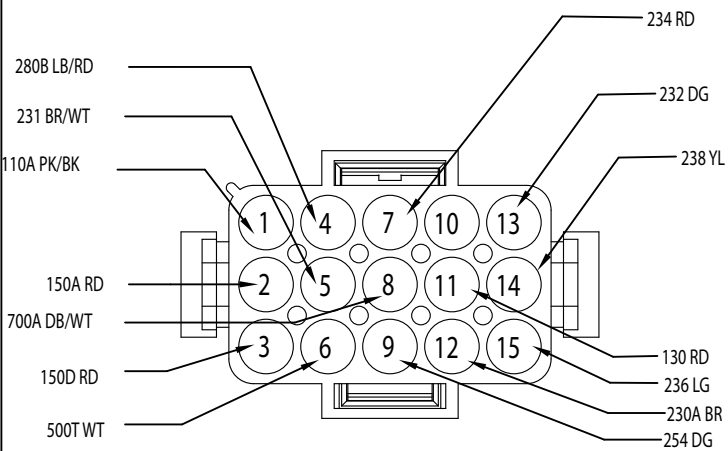

10.3
POWER FEED #1
770023-1

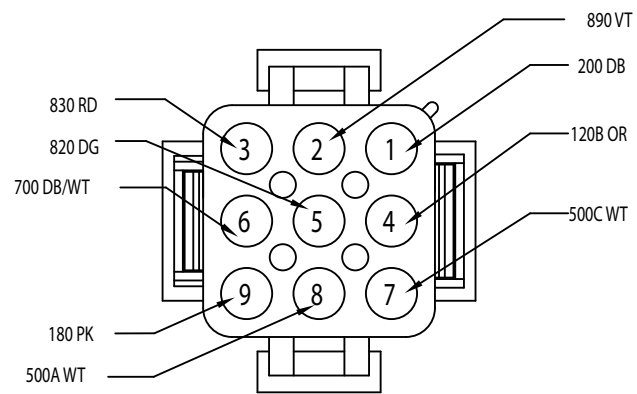

10.4
POWER FEED #2
770021-1

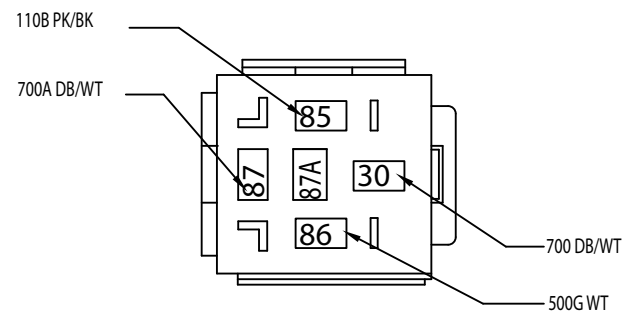

10.5
HVAC POWER RELAY
12033871

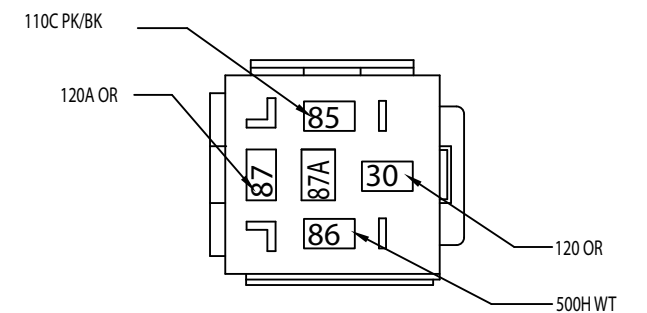

10.6
WIPER POWER RELAY
12033871

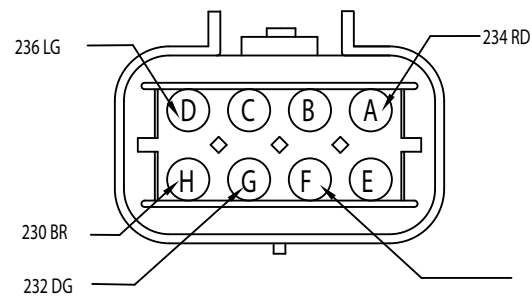

10.12
BODY BUILDER CONNECTOR
15326655

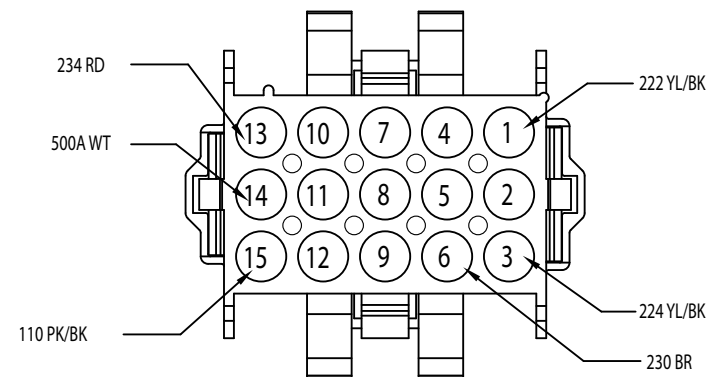

11.1
TO "A" PILLAR HARNESS
770030-1

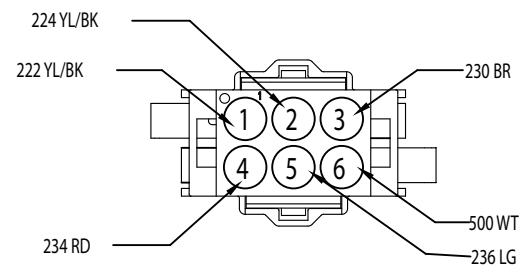

11.5
REAR CLEARANCE LIGHT HARNESS
770027-1

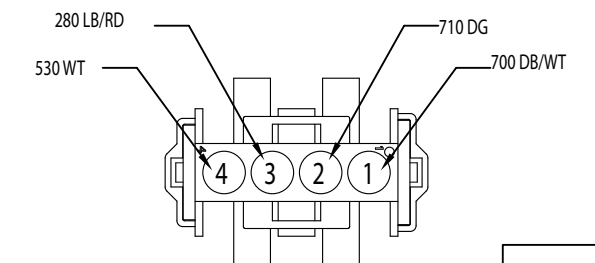

13.1
TO MAIN DASH HARNESS
770026-1

| LEGEND | |
|--------|---------------------|
| | HOT AT ALL TIMES |
| | HOT IN RUN OR START |
| | HOT IN ACC OR RUN |

PAGE 7 OF 12

| | | | | | | | | | | | | |
|------------------------|--|--|--|--|--------|------|----|-------------|----------|----------|-------------------------------------------------------------------|--------------------------|
| RELEASE FOR PRODUCTION | | | | | 515140 | | | | ENGINEER | DRAWN BY | Spartan Motors USA, Inc. 603 Earthway Blvd Bristol, N 46507 | TITLE |
| REVISIONS | | | | | AUTH | DATE | BY | CHECKED BY | RLC | JYD | | SCHEMATIC |
| | | | | | | | | APPROVED BY | RLC | 02/17/17 | CAGE CODE | FREIGHTLINER MT45 |
| | | | | | | | | | | | DWG NUMBER | 58232644 |
| | | | | | | | | | | | 36MV0 | A |

THE INFORMATION CONTAINED IN THIS DRAWING IS THE SOLE PROPERTY OF SPARTAN MOTORS USA, INC. ANY REPRODUCTION IN PART OR AS A WHOLE WITHOUT THE WRITTEN PERMISSION OF SPARTAN MOTORS USA, INC. IS PROHIBITED. DOCUMENT IS ELECTRONICALLY CONTROLLED. VERIFY REV PRIOR TO USE.

CONNECTOR VIEW

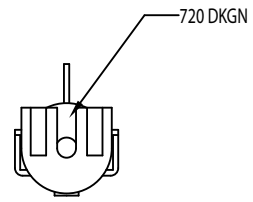

15.1
TO UNDERHOOD A/C SIGNAL FEED
12010996

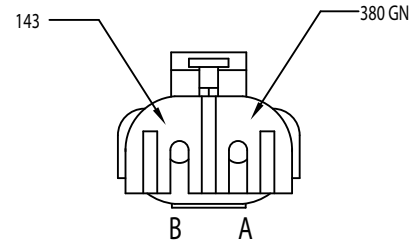

16.1
CONNECTOR, 2-WAY WEATHER PACK TOWER
12015792

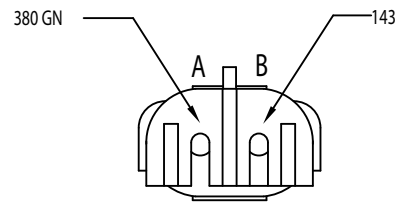

16.2
CONNECTOR, 2-WAY WEATHER PACK SHROUD
12010973

LEGEND

| | |
|------|---------------------|
| BATT | HOT AT ALL TIMES |
| IGN | HOT IN RUN OR START |
| ACC | HOT IN ACC OR RUN |

| | | | | | | | | | | | |
|--------------|------|------------------------|--------|------|----|------------|-------------|------------|----------|----------------------------------------------------------------------------------------------------------------------------------------------------------------------------------------------------|----------------------------------------|
| PAGE 8 OF 12 | REV. | REVISIONS | AUTH | DATE | BY | CHECKED BY | APPROVED BY | ENGINEER | DRAWN BY | Spartan Motors USA, Inc. 603 Earthway Blvd Bristol, N 46507 | TITLE |
| | A | RELEASE FOR PRODUCTION | 515140 | | | RLC | RLC | --- | JYD | | SCHEMATIC FREIGHTLINER MT45 |
| | | | | | | | | CHECKED BY | DATE | THE INFORMATION CONTAINED IN THIS DRAWING IS THE SOLE PROPERTY OF SPARTAN MOTORS USA, INC. ANY RE PRODUCTION IN PART OR AS A WHOLE WITHOUT THE WRITTEN PERMISSION OF SPARTAN MOTORS IS PROHIBITED. | CAGE CODE |
| | | | | | | | | RLC | 02/17/17 | DOCUMENT IS ELECTRONICALLY CONTROLLED. VERIFY REV PRIOR TO USE. | DWG NUMBER |
| | | | | | | | | | | 36MV0 | 58232644 |

CONNECTOR LOCATING

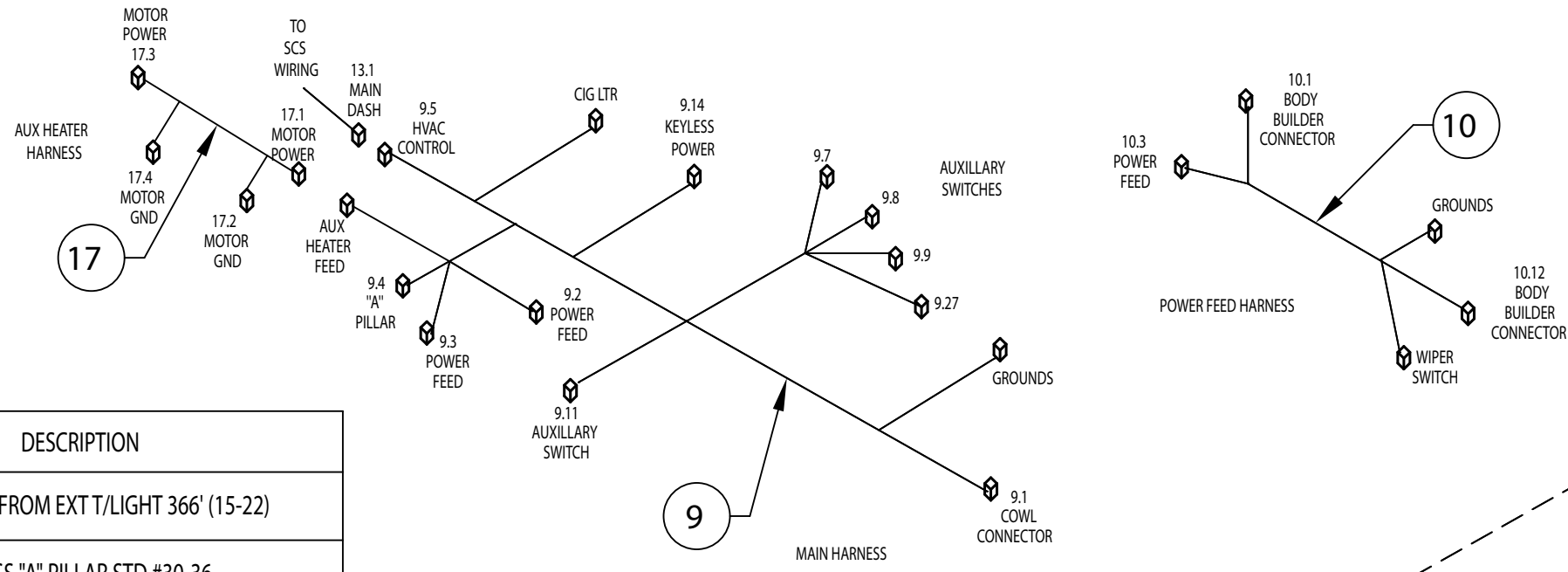

9

10

4

8

5

1

12

3

15

11

14

6

2

7

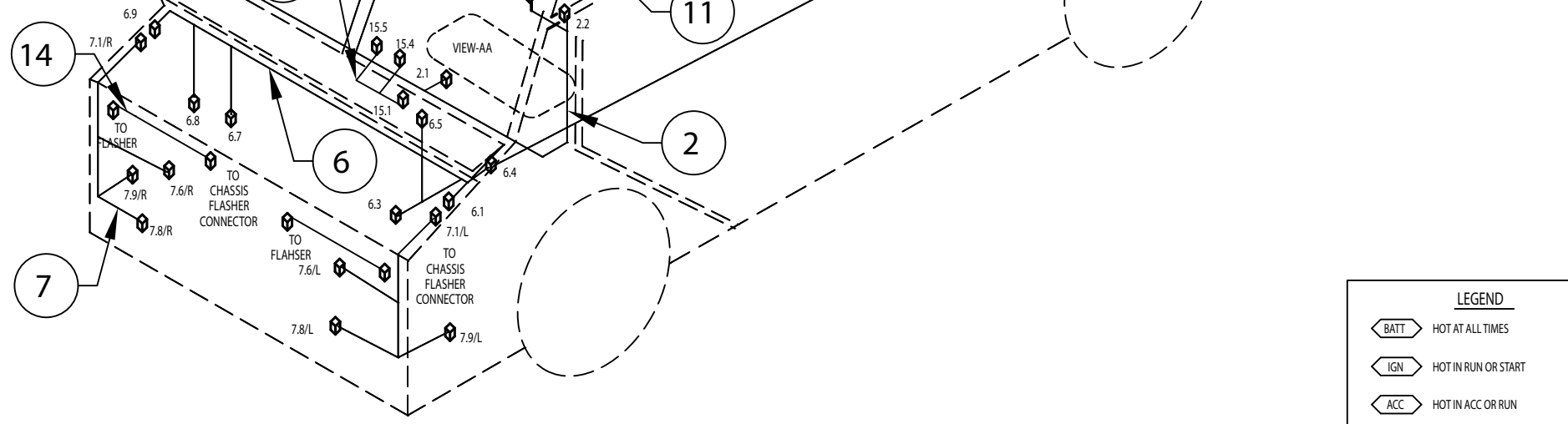

| LEGEND | |
|--------|---------------------|
| | HOT AT ALL TIMES |
| | HOT IN RUN OR START |
| | HOT IN ACC OR RUN |

| M.NO | HARNESS NUMBER | DESCRIPTION |
|------|----------------|---------------------------------------|
| 1 | 16514516-36600 | HARNESS FROM EXT T/LIGHT 366' (15-22) |
| 2 | 16400487 | HARNESS "A" PILLAR STD #30-36 |
| 3 | 16512062 | HARNESS CLRNS/CENTRAL GROUND |
| 4 | 16512066 | HARNESS RR CL LGT/CENTRAL GRD |
| 5 | 16514514 | HARNESS STANDARD REAR STRUCTURE |
| 6 | 16517040 | HARNESS HDLP/WIPER M2000 |
| 7 | 16516613 | HARNESS HEADLAMP/TURN IND LED TURN |
| 8 | 16516661 | HARNESS REAR LIGHTS UNIVERSAL LED |
| 9 | 16517256 | HARNESS MAIN DASH |
| 10 | 16517261 | HARNESS POWER FEED FCCC MY'141 |
| 11 | 16516727-004 | HARNESS ROOF UNIVERSAL 15'-18' |
| 12 | 16513694 | HARNESS BACKUP ALARM JUMPER |
| 13 | 16514775 | HARNESS CABLE TO ELEC HVAC ADAPTER |
| 14 | 16513731 | HARNESS FLASHER 1419 |
| 15 | 16514537 | HARNESS AC FRTRLR ISB 07 W/FAN |
| 16 | 16515000 | HARNESS ELEC FAN CLUTCH FCCC 2010 |
| 17 | 16516409 | HARNESS AUX HEATER 15KBTU |

PAGE 9 OF 12

| | | | | | | | | | | | | |
|-------------------------------|-----------|------|------|--------|------------|-------------|----------|----------|-----------|------------|-------------------------------------------------------------------|-------|
| RELEASE FOR PRODUCTION | | | | 515140 | | | | | ENGINEER | DRAWN BY | Spartan Motors USA, Inc. 603 Earthway Blvd Bristol, N 46507 | TITLE |
| REV. | REVISIONS | AUTH | DATE | BY | CHECKED BY | APPROVED BY | ENGINEER | DATE | CAGE CODE | DWG NUMBER | | |
| | | | | | RLC | RLC | | 02/17/17 | | 36MV0 | 58232644 | A |

THE INFORMATION CONTAINED IN THIS DRAWING IS THE SOLE PROPERTY OF SPARTAN MOTORS USA, INC. ANY REPRODUCTION IN PART OR AS A WHOLE WITHOUT THE WRITTEN PERMISSION OF SPARTAN MOTORS USA, INC. IS PROHIBITED. DOCUMENT IS ELECTRONICALLY CONTROLLED. VERIFY REV PRIOR TO USE.

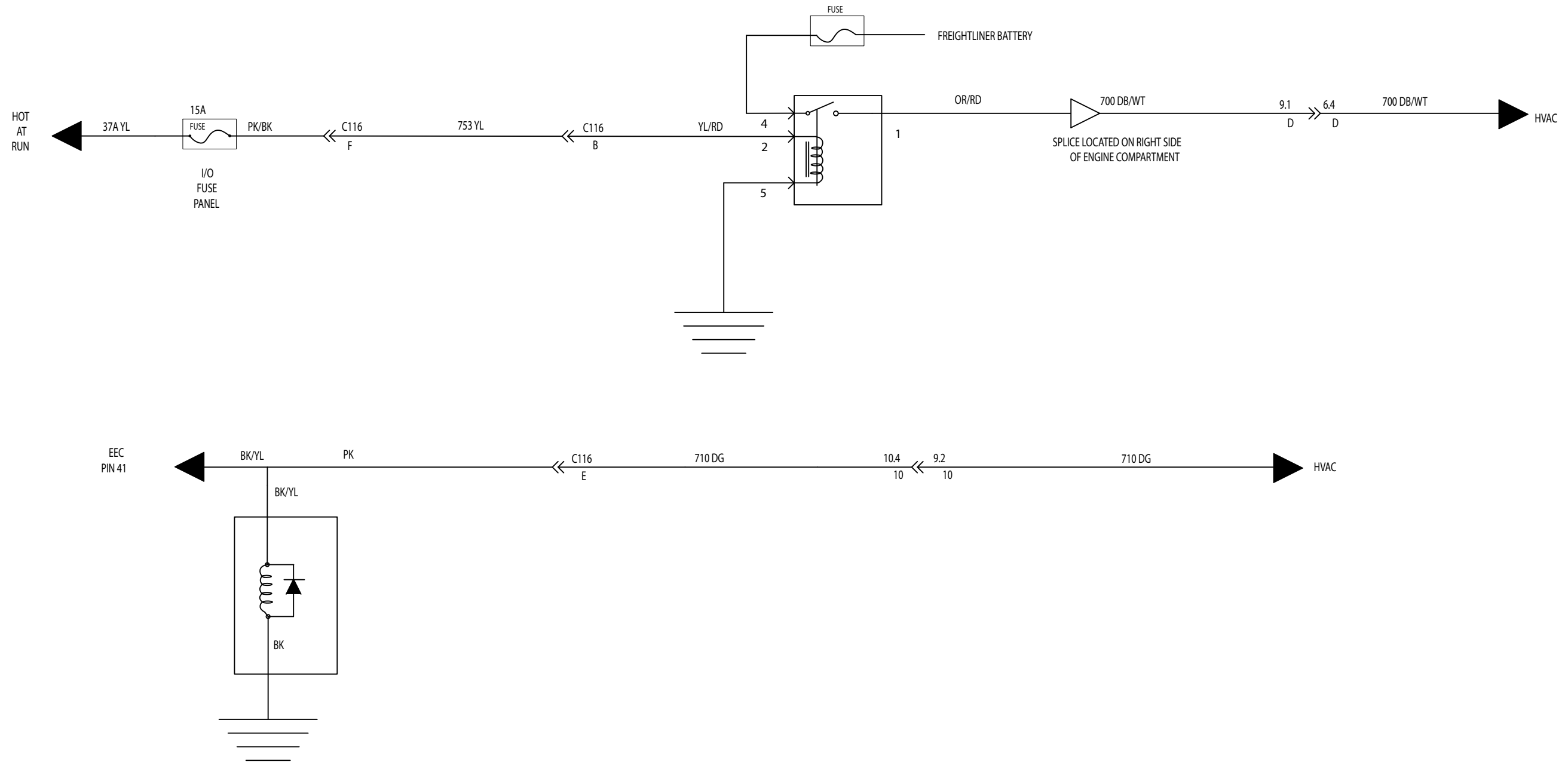

| LEGEND | |
|--------|---------------------|
| | HOT AT ALL TIMES |
| | HOT IN RUN OR START |
| | HOT IN ACC OR RUN |

| | | | | | |
|---------------|------------|-----------------|-------------------------------------------------------------------|------------|----------------------------------------|
| PAGE 10 OF 12 | ENGINEER | DRAWN BY | Spartan Motors USA, Inc. 603 Earthway Blvd Bristol, N 46507 | TITLE | SCHEMATIC FREIGHTLINER MT45 |
| | --- | JYD | | CAGE CODE | 36MV0 |
| REV. A | CHECKED BY | DATE | DOCUMENT IS ELECTRONICALLY CONTROLLED. VERIFY REV PRIOR TO USE. | DWG NUMBER | 58232644 |
| REVISIONS | RLC | 02/17/17 | | | A |
| | AUTH | DATE | BY | CHECKED BY | APPROVED BY |
| | | | | | |

POWER DISTRIBUTION

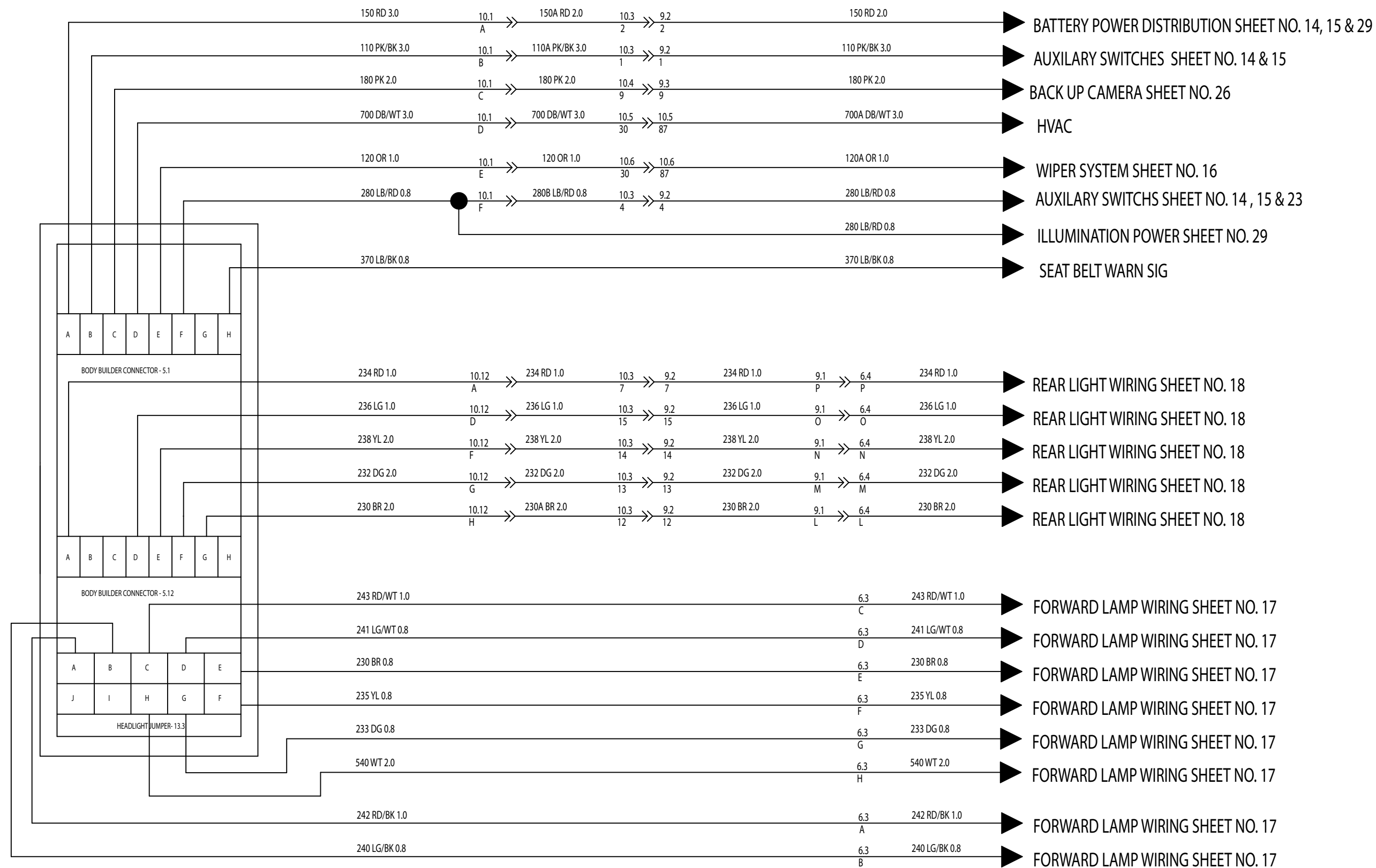

CHASSIS POWER DISTRIBUTION

| LEGEND | |
|--------|---------------------|
| BATT | HOT AT ALL TIMES |
| IGN | HOT IN RUN OR START |
| ACC | HOT IN ACC OR RUN |

PAGE 11 OF 12

| | | | | | | | | | | | | | | | |
|-------------------------------|-----------|--|--|--------|------|----|------------|-------------|-----|----------|----------|-------------------------------------------------------------------|-------|------------------|----------|
| RELEASE FOR PRODUCTION | | | | 515140 | | | | ENGINEER | --- | DRAWN BY | JYD | Spartan Motors USA, Inc. 603 Earthway Blvd Bristol, N 46507 | TITLE | SCHEMATIC | |
| REV. | REVISIONS | | | AUTH | DATE | BY | CHECKED BY | APPROVED BY | RLC | DATE | 02/17/17 | CAGE CODE | 36MV0 | DWG NUMBER | 58232644 |

THE INFORMATION CONTAINED IN THIS DRAWING IS THE SOLE PROPERTY OF SPARTAN MOTORS USA, INC. ANY REPRODUCTION IN PART OR AS A WHOLE WITHOUT THE WRITTEN PERMISSION OF SPARTAN MOTORS IS PROHIBITED. DOCUMENT IS ELECTRONICALLY CONTROLLED. VERIFY REV PRIOR TO USE.

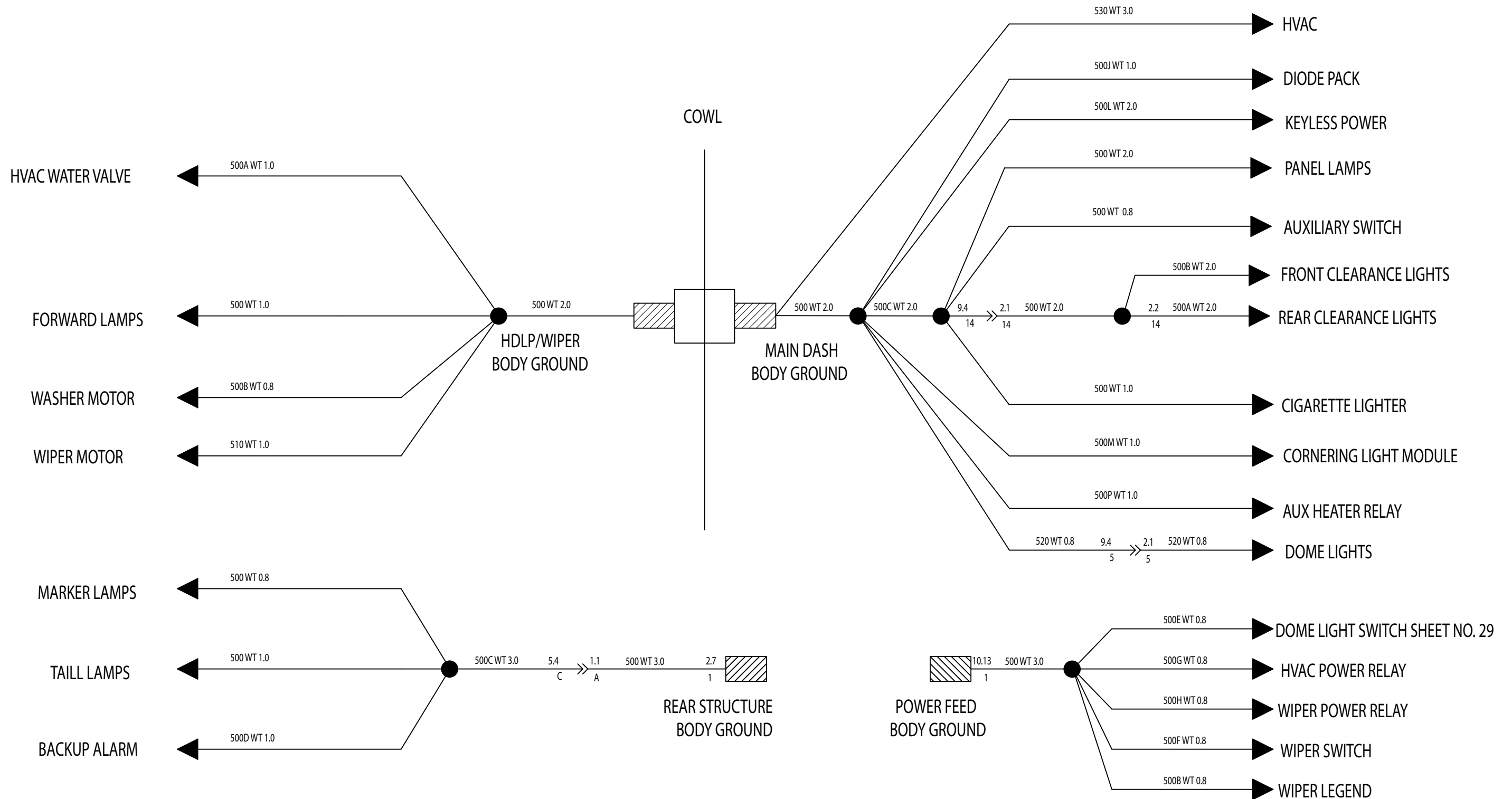

| LEGEND | |
|--------|---------------------|
| | HOT AT ALL TIMES |
| | HOT IN RUN OR START |
| | HOT IN ACC OR RUN |

| | | | | | | | | | | |
|-------------------------------|-----------|------|------|----|------------|-------------|------------|-------------------------------------------------------------------|--|------------------|
| PAGE 12 OF 12 | | | | | | ENGINEER | DRAWN BY | Spartan Motors USA, Inc. 603 Earthway Blvd Bristol, N 46507 | | TITLE |
| | | | | | | --- | JYD | | | SCHEMATIC |
| RELEASE FOR PRODUCTION | | | | | 515140 | RLC | DATE | CAGE CODE | | DWG NUMBER |
| REV. | REVISIONS | AUTH | DATE | BY | CHECKED BY | APPROVED BY | 02/17/17 | 36MV0 | | 58232644 |

THE INFORMATION CONTAINED IN THIS DRAWING IS THE SOLE PROPERTY OF SPARTAN MOTORS USA, INC. ANY REPRODUCTION IN PART OR AS A WHOLE WITHOUT THE WRITTEN PERMISSION OF SPARTAN MOTORS IS PROHIBITED. DOCUMENT IS ELECTRONICALLY CONTROLLED. VERIFY REV PRIOR TO USE.

SWITCHES

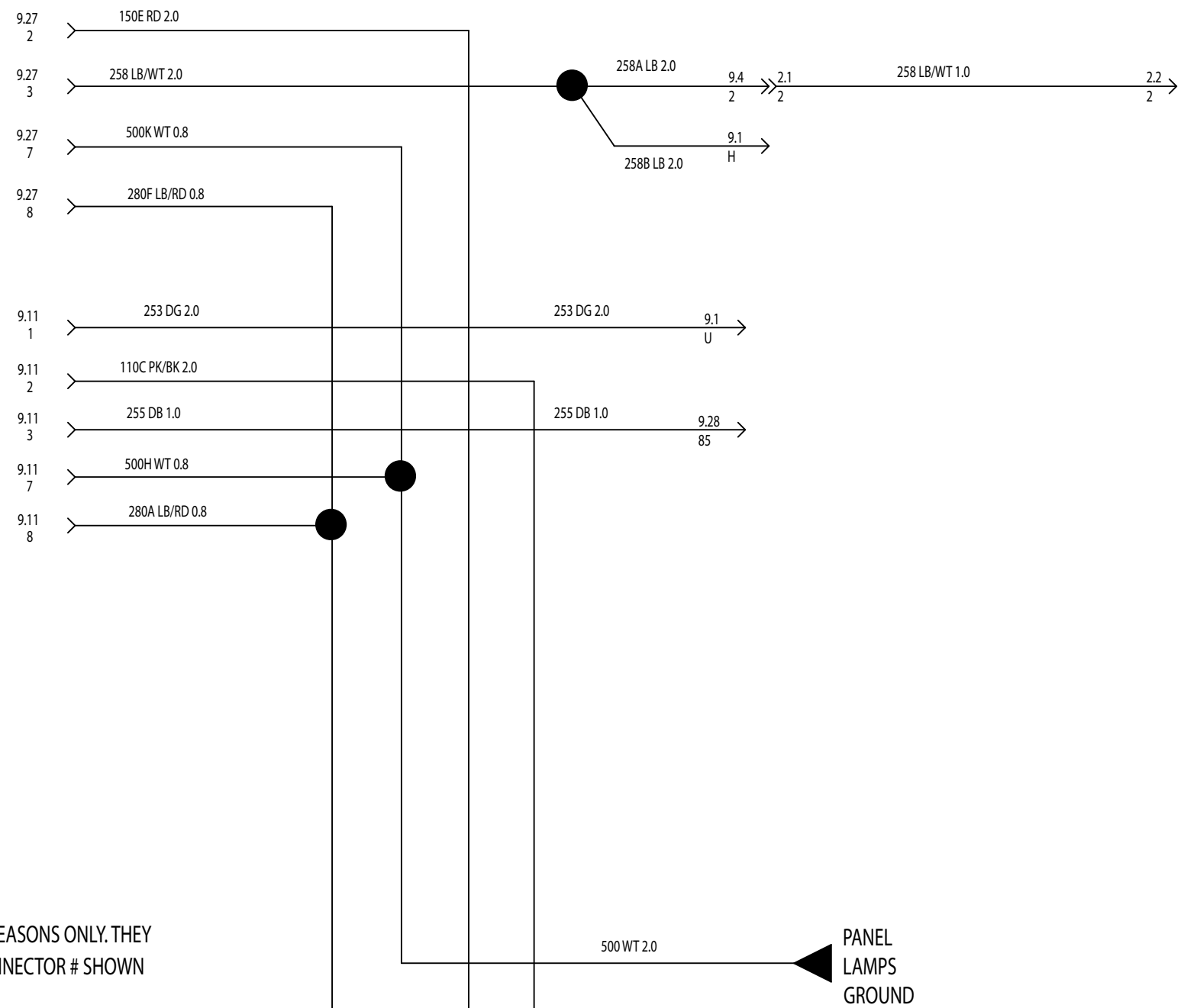
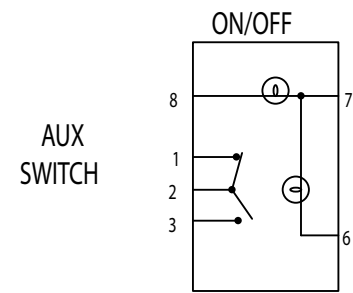
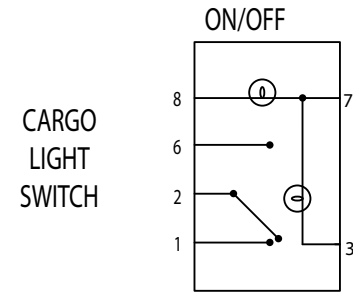

SWITCHES SHOWN ARE VISUAL FUNCTIONAL REASONS ONLY. THEY ARE NOT NECESSARILY MATCHED TO THE CONNECTOR # SHOWN

ILLUMINATION POWER DISTRIBUTION

POWER DISTRIBUTION

IGNITION POWER DISTRIBUTION

| LEGEND | |
|--------|---------------------|
| | HOT AT ALL TIMES |
| | HOT IN RUN OR START |
| | HOT IN ACC OR RUN |

PAGE 3 OF 12

| | | | | | | | | | | | | |
|---------------------------------------------------------------------------------------------------------------------------------------------------------------------------------------------------|-----------|--|--|--------|------|----|------------|-------------|----------|----------|-------------------------------------------------------------------|-------------------------------|
| RELEASE FOR PRODUCTION | | | | 515140 | | | | | ENGINEER | DRAWN BY | Spartan Motors USA, Inc. 603 Earthway Blvd Bristol, N 46507 | TITLE |
| REV. | REVISIONS | | | AUTH | DATE | BY | CHECKED BY | APPROVED BY | RLC | RLC | 02/17/17 | SCHMATIC FREIGHTLINER MT45 |
| THE INFORMATION CONTAINED IN THIS DRAWING IS THE SOLE PROPERTY OF SPARTAN MOTORS USA, INC. ANY REPRODUCTION IN PART OR AS A WHOLE WITHOUT THE WRITTEN PERMISSION OF SPARTAN MOTORS IS PROHIBITED. | | | | | | | | | | | CAGE CODE | DWG NUMBER |
| DOCUMENT IS ELECTRONICALLY CONTROLLED. VERIFY REV PRIOR TO USE. | | | | | | | | | | | 36MV0 | 58232644 |

WIPER SYSTEM

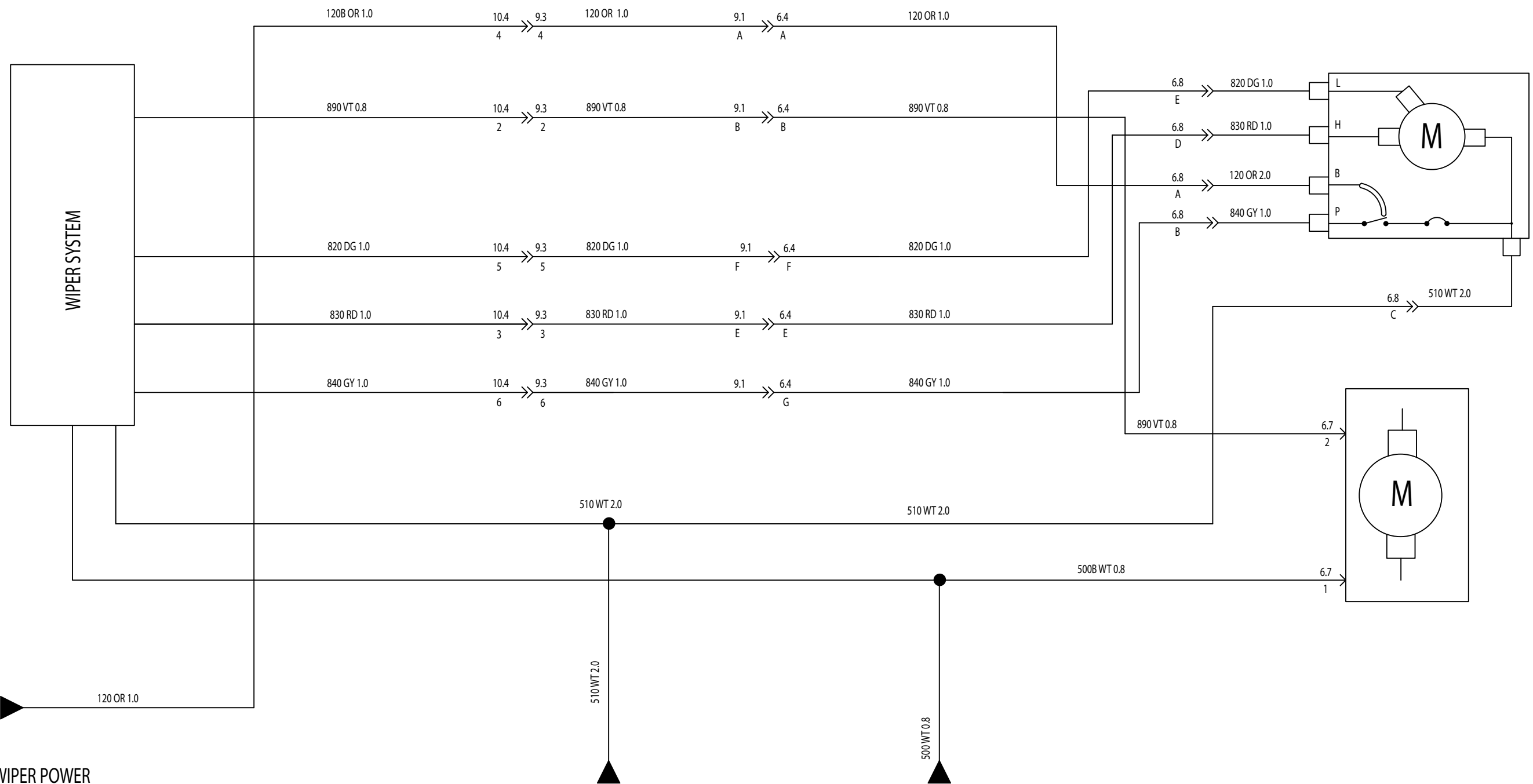

WIPER POWER SHEET NO. 11

- 120 OR - WIPER POWER
- 510 WT - WIPER MOTOR GROUND
- 820 DG - LOW SPEED
- 840 GY - PARK
- 830 RD - HIGH SPEED
- 890A VT - WASHER PUMP

| LEGEND | |
|--------|---------------------|
| | HOT AT ALL TIMES |
| | HOT IN RUN OR START |
| | HOT IN ACC OR RUN |

| | | | | | | | | | | | | | |
|--------------|---|------------------------|--------|------|----|------------|-------------|----------|----------|-------------------------------------------------------------------|-------|-----------|------------|
| PAGE 4 OF 12 | A | RELEASE FOR PRODUCTION | 515140 | DATE | BY | CHECKED BY | APPROVED BY | ENGINEER | DRAWN BY | Spartan Motors USA, Inc. 603 Earthway Blvd Bristol, N 46507 | TITLE | CAGE CODE | DWG NUMBER |
| | | | | | | | | --- | JYD | | | | |

SCHEMATIC FREIGHTLINER MT45

58232644

FROM
 POWER DISTRIBUTION
 SHEET NO. 11

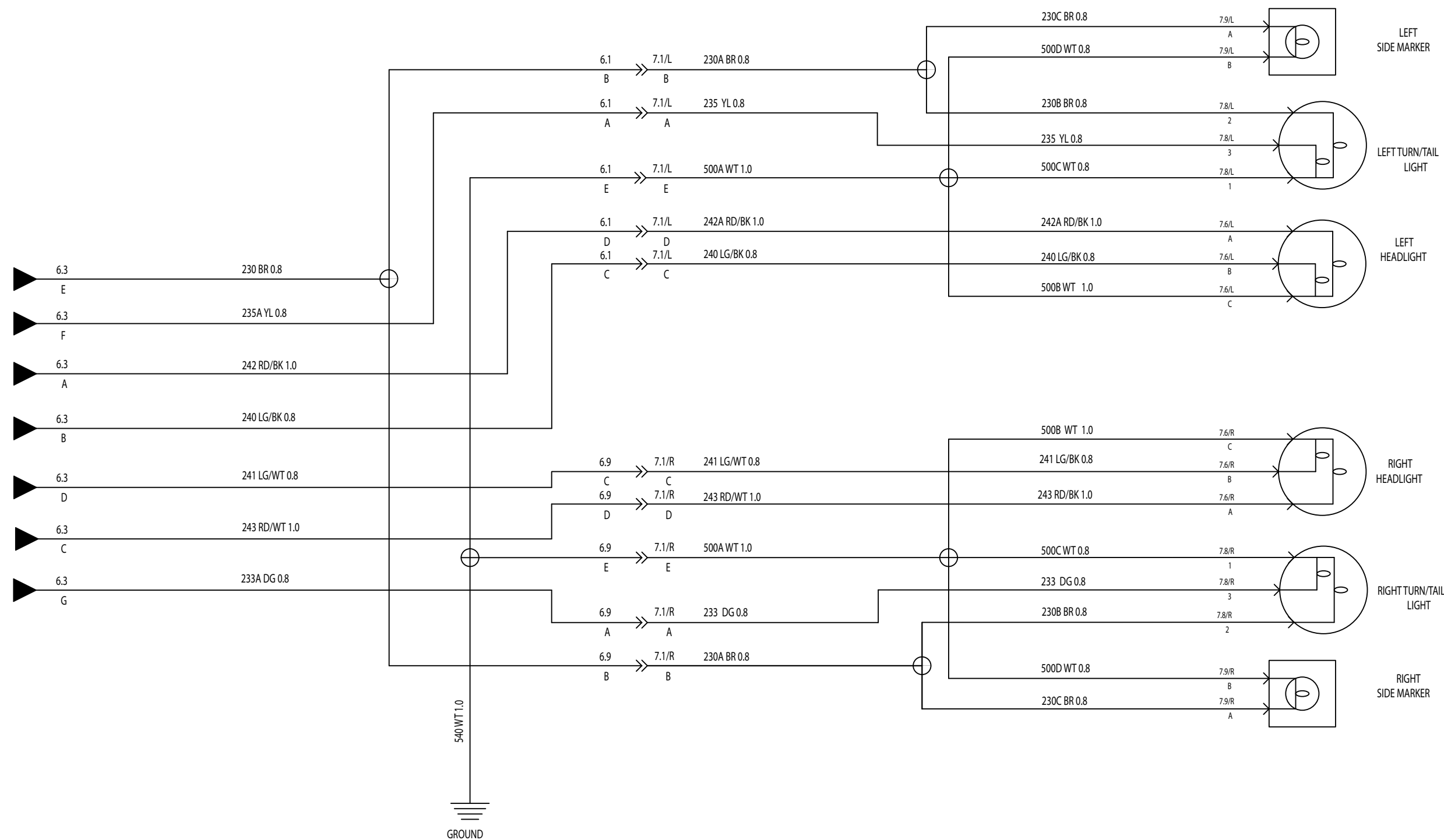

| LEGEND | |
|--------|---------------------|
| | HOT AT ALL TIMES |
| | HOT IN RUN OR START |
| | HOT IN ACC OR RUN |

| | | | | | | | | |
|------------|-----|-----------|----------|-------------------------------------------------------------------|-------|------------|----------------------------------------|-------------|
| ENGINEER | --- | DRAWN BY | JYD | Spartan Motors USA, Inc. 603 Earthway Blvd Bristol, N 46507 | | TITLE | SCHEMATIC FREIGHTLINER MT45 | |
| CHECKED BY | RLC | DATE | 02/17/17 | CAGE CODE | 36MV0 | DWG NUMBER | 58232644 A | |
| REV. | A | REVISIONS | 515140 | AUTH | DATE | BY | CHECKED BY | APPROVED BY |

PAGE 5 OF 12

REAR LIGHT WIRING-STANDARD

FROM
POWER DISTRIBUTION
SHEET NO. 11

BATTERY POWER

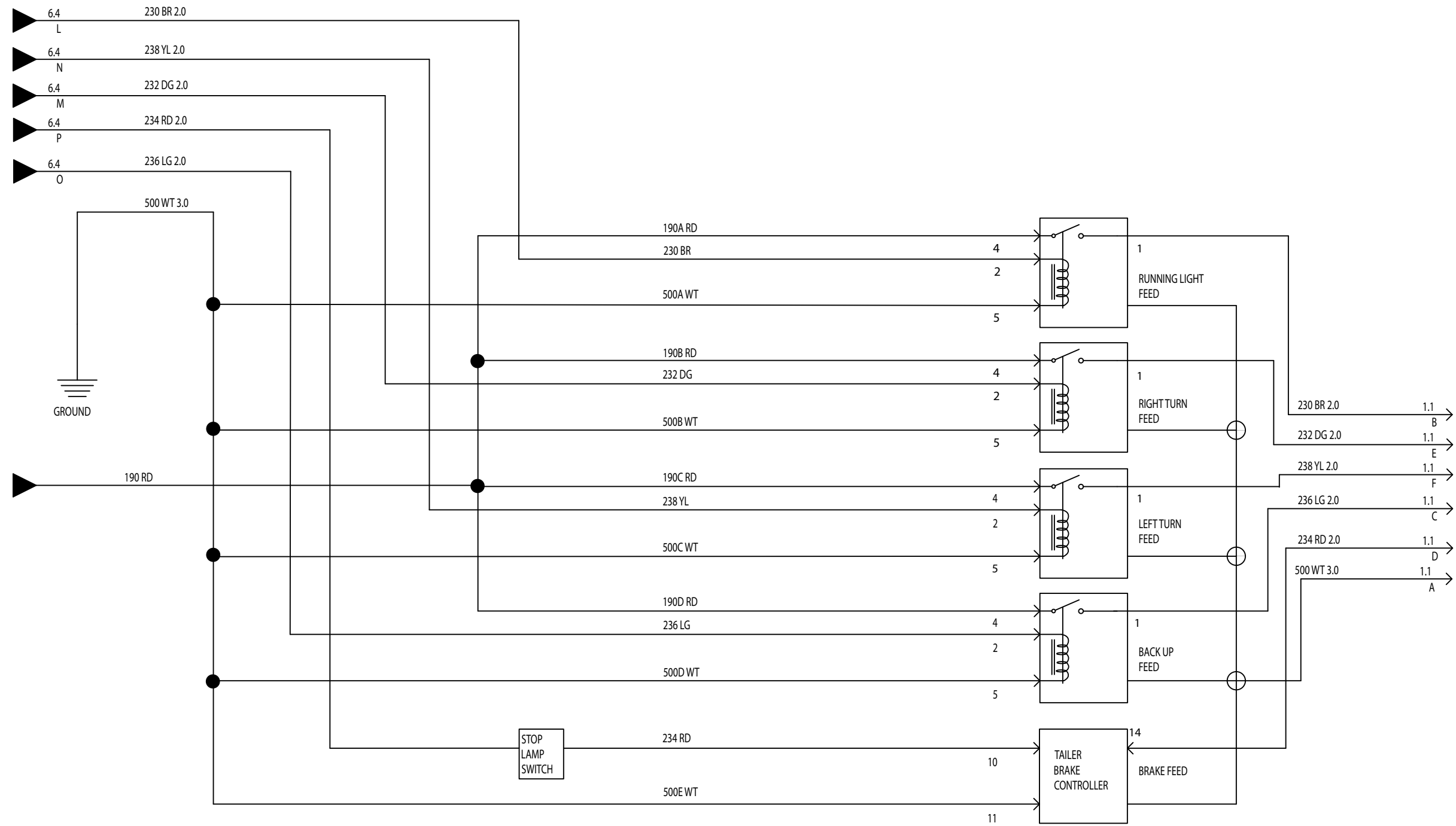

TO
REAR LIGHT
WIRING
SHEET NO. 19

| LEGEND | |
|--------|---------------------|
| | HOT AT ALL TIMES |
| | HOT IN RUN OR START |
| | HOT IN ACC OR RUN |

PAGE 6 OF 12

| | | | | | | | | | | | |
|--------------------------|--|--|--|--------|------|----|-------------|----------|----------|-------------------------------------------------------------------------------------------------------------------------------------------------------------------------------------------------------------|------------|
| A RELEASE FOR PRODUCTION | | | | 515140 | | | | ENGINEER | DRAWN BY | Spartan Motors USA, Inc. 603 Earthway Blvd Bristol, N 46507 | TITLE |
| REVISIONS | | | | AUTH | DATE | BY | CHECKED BY | RLC | JYD | | SCHMATIC |
| | | | | | | | APPROVED BY | RLC | 02/17/17 | CAGE CODE | DWG NUMBER |
| | | | | | | | | | | 36MV0 | 58232644 |
| | | | | | | | | | | THE INFORMATION CONTAINED IN THIS DRAWING IS THE SOLE PROPERTY OF SPARTAN MOTORS USA, INC. ANY REPRODUCTION IN PART OR AS A WHOLE WITHOUT THE WRITTEN PERMISSION OF SPARTAN MOTORS USA, INC. IS PROHIBITED. | A |

REAR LIGHT WIRING-STANDARD

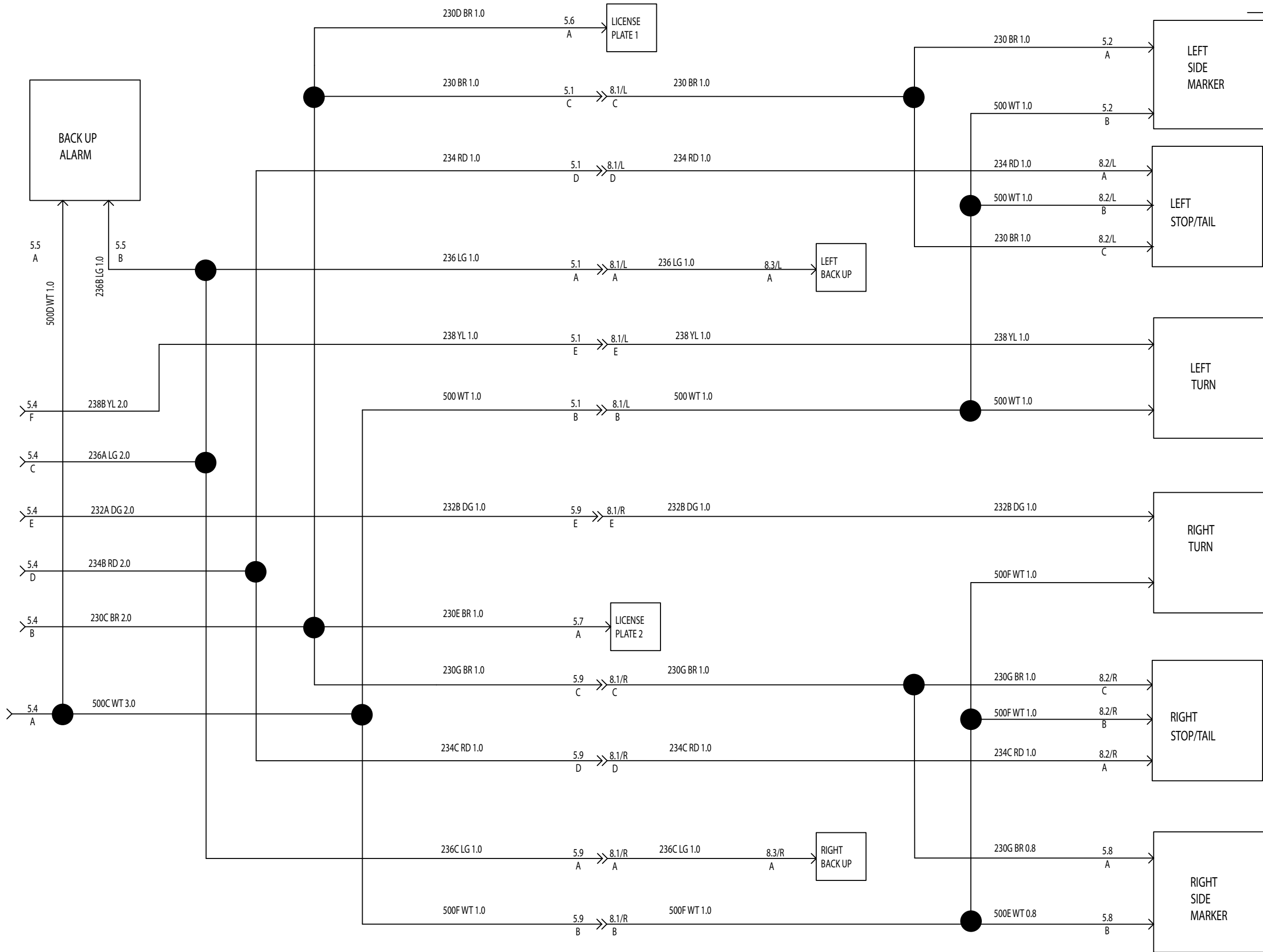

FROM REAR LIGHT WIRING SHEET NO. 18

LEGEND

| | |
|------|---------------------|
| BATT | HOT AT ALL TIMES |
| IGN | HOT IN RUN OR START |
| ACC | HOT IN ACC OR RUN |

PAGE 7 OF 12

| | | | | | | | | | | | | |
|--------------------------------------|--|--|--|--|---------------|-------------|-----------------|-------------------|--------------------|-----------------|----------------------------------------------------------------------------|-------------------|
| <p>RELEASE FOR PRODUCTION</p> | | | | | <p>515140</p> | <p>RLC</p> | <p>02/17/17</p> | <p>RLC</p> | <p>ENGINEER</p> | <p>DRAWN BY</p> | <p>Spartan Motors USA, Inc. 603 Earthway Blvd Bristol, N 46507</p> | <p>TITLE</p> |
| <p>REVISIONS</p> | | | | | <p>AUTH</p> | <p>DATE</p> | <p>BY</p> | <p>CHECKED BY</p> | <p>APPROVED BY</p> | <p>JYD</p> | <p>CAGE CODE</p> | <p>DWG NUMBER</p> |
| | | | | | <p>A</p> | | | | | | <p>36MV0</p> | <p>58232644</p> |

THE INFORMATION CONTAINED IN THIS DRAWING IS THE SOLE PROPERTY OF SPARTAN MOTORS USA, INC. ANY REPRODUCTION IN PART OR AS A WHOLE WITHOUT THE WRITTEN PERMISSION OF SPARTAN MOTORS IS PROHIBITED. DOCUMENT IS ELECTRONICALLY CONTROLLED. VERIFY REV PRIOR TO USE.

CLEARANCE LIGHTS

FRONT CLEARANCE
LIGHT
SHEET NO. 21

CLEARANCE LIGHTS
POWER FEED #1

REAR CLEARANCE
LIGHT
SHEET NO. 22

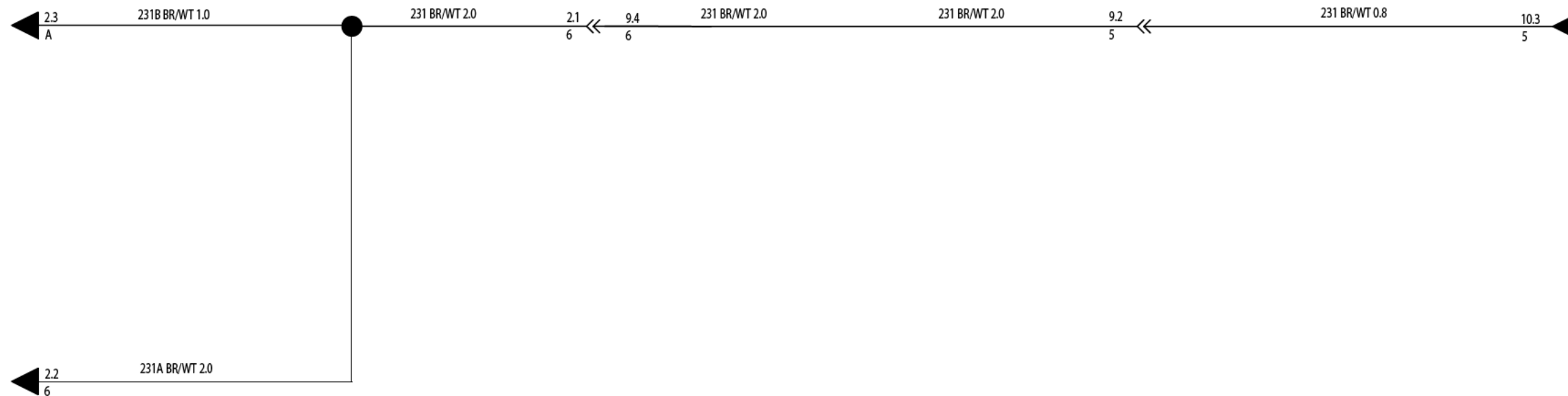

LEGEND

| | |
|------|---------------------|
| BATT | HOT AT ALL TIMES |
| IGN | HOT IN RUN OR START |
| ACC | HOT IN ACC OR RUN |

PAGE 8 OF 12

| | | | | | | | | | | | |
|--------------------------------------|-----------|--------|------|----|------------|-------------|--|--------------------------|------------------------|------------------------------------------------------------------------------------------------------------------------------------------------------------------------------------------------------------------------------------------------------------------------------------------------|------------------------------------------------------------------|
| <p>RELEASE FOR PRODUCTION</p> | | 515140 | | | | | | ENGINEER --- | DRAWN BY JYD | Spartan Motors USA, Inc. 603 Earthway Blvd Bristol, N 46507 | TITLE SCHEMATIC FREIGHTLINER MT45 |
| REV. | REVISIONS | AUTH | DATE | BY | CHECKED BY | APPROVED BY | | CHECKED BY RLC | DATE 02/17/17 | <p><small>THE INFORMATION CONTAINED IN THIS DRAWING IS THE SOLE PROPERTY OF SPARTAN MOTORS USA, INC. ANY REPRODUCTION IN PART OR AS A WHOLE WITHOUT THE WRITTEN PERMISSION OF SPARTAN MOTORS IS PROHIBITED.</small></p> <p>DOCUMENT IS ELECTRONICALLY CONTROLLED. VERIFY REV PRIOR TO USE.</p> | <p>CAGE CODE 36MV0</p> <p>DWG NUMBER 58232644</p> |

REAR CLEARANCE LIGHT

FROM
CLEARANCE LIGHT SYSTEM
SHEET NO. 20

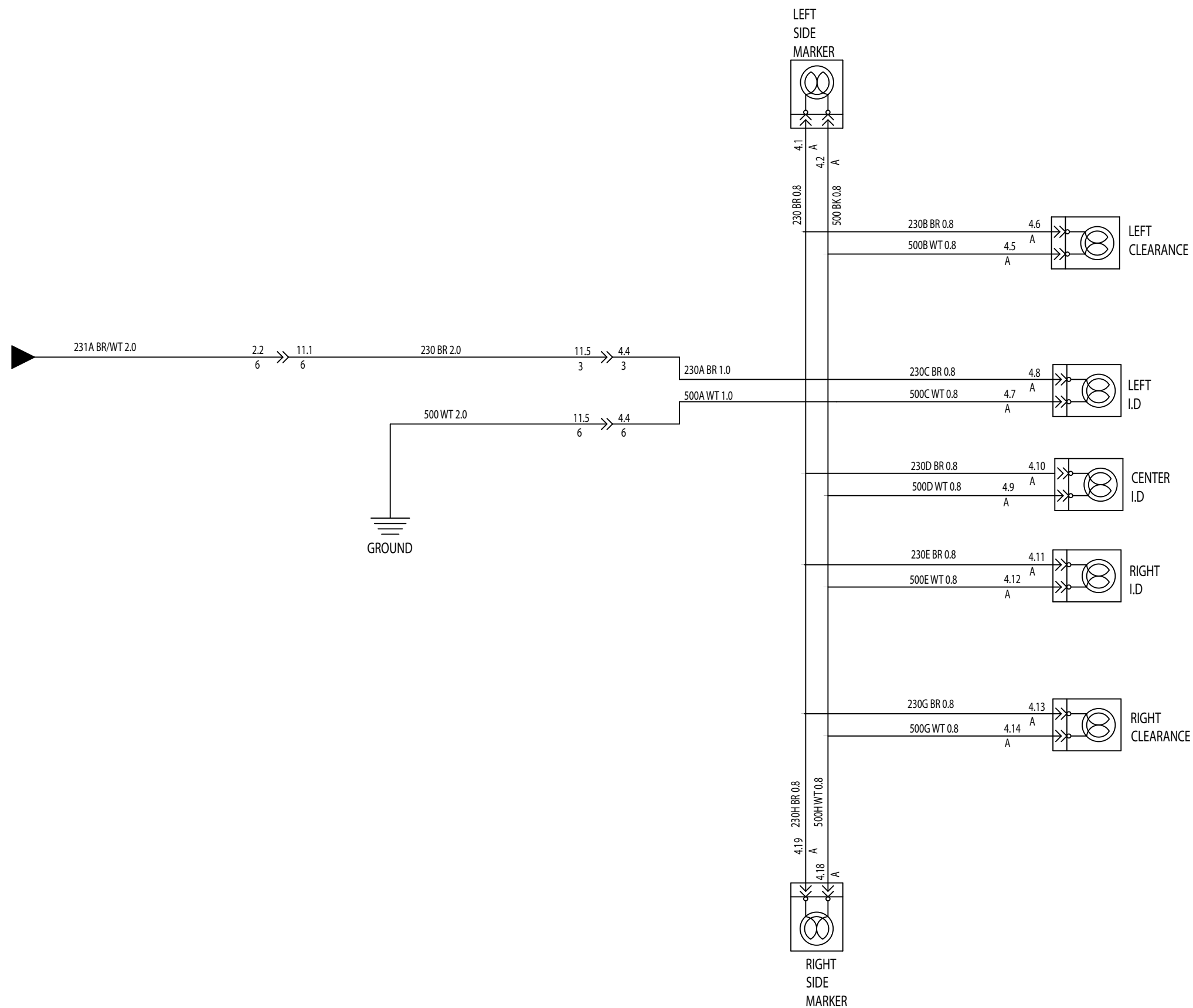

| LEGEND | |
|--------|---------------------|
| | HOT AT ALL TIMES |
| | HOT IN RUN OR START |
| | HOT IN ACC OR RUN |

| | | | | | | | |
|-----------------------------------------------------------------------------------------------------------------------------------------------------------------------------------------------------------------------------------------------------------------------------|-----------|------------|-------------------------------------------------------------------|------|------------|----------------------------------------|-----------------|
| PAGE 1 OF 12 | ENGINEER | DRAWN BY | Spartan Motors USA, Inc. 603 Earthway Blvd Bristol, N 46507 | | TITLE | SCHEMATIC FREIGHTLINER MT45 | |
| | --- | JYD | CHECKED BY | DATE | CAGE CODE | DWG. NUMBER | |
| RELEASE FOR PRODUCTION | | | 515140 | | | | |
| REV. | REVISIONS | AUTH | DATE | BY | CHECKED BY | APPROVED BY | |
| | | | | | RLC | RLC | |
| | | | | | | 02/17/17 | |
| THE INFORMATION CONTAINED IN THIS DRAWING IS THE SOLE PROPERTY OF SPARTAN MOTORS USA, INC. ANY REPRODUCTION IN PART OR AS A WHOLE WITHOUT THE WRITTEN PERMISSION OF SPARTAN MOTORS USA, INC. IS PROHIBITED. DOCUMENT IS ELECTRONICALLY CONTROLLED. VERIFY REV PRIOR TO USE. | | | | | | 36MV0 | 58232644 |

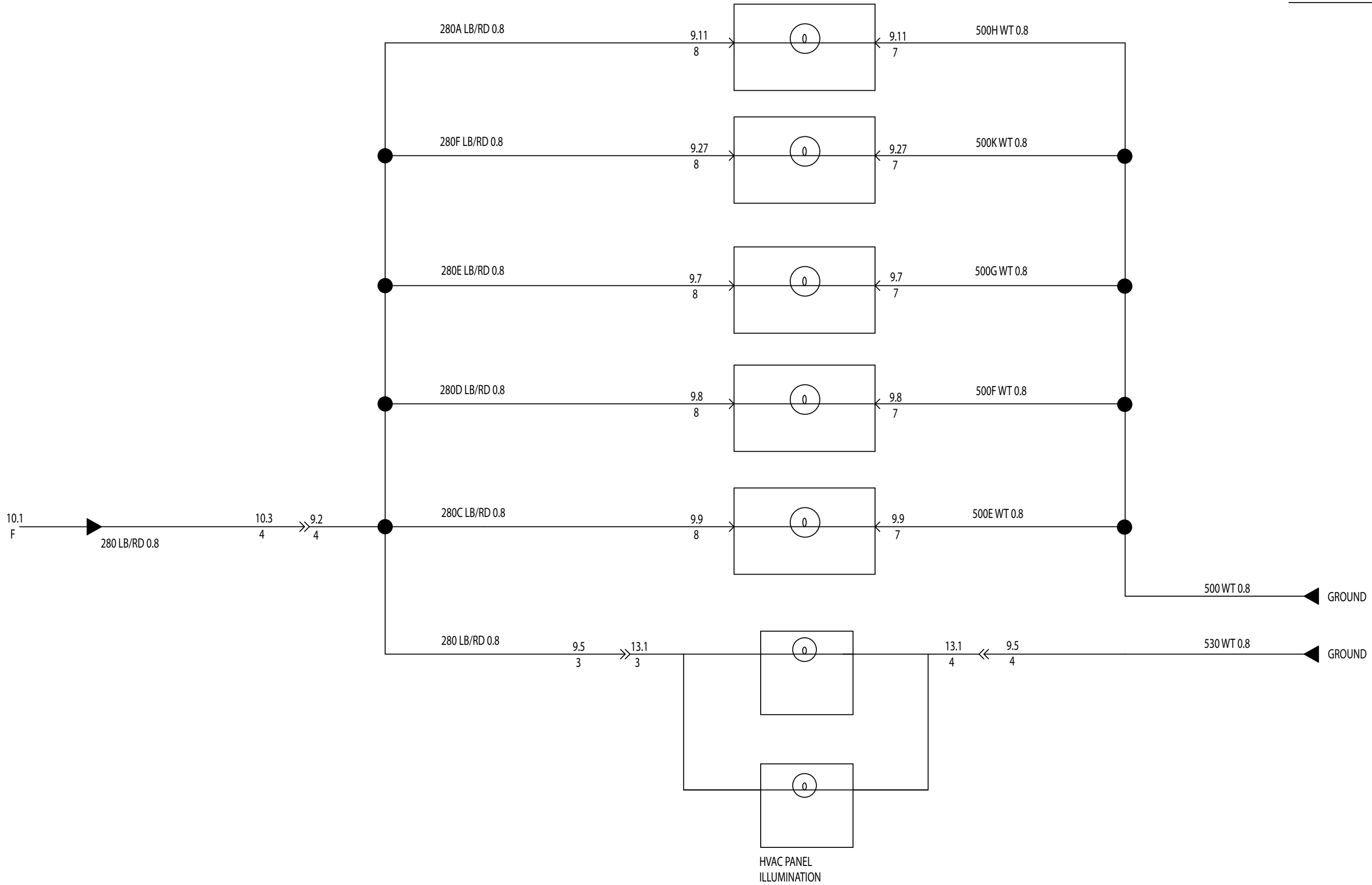

| LEGEND | |
|--------|---------------------|
| | HOT AT ALL TIMES |
| | HOT IN RUN OR START |
| | HOT IN ACC OR RUN |

| | | | | | | | | | | | | | | | |
|---------------|-------------------------------|--|--|--|--|----------|----------|-------------------------------------------------------------------|--------------------------------|-------------|----------|-------|-----------|------------|--|
| PAGE 11 OF 12 | | | | | | ENGINEER | DRAWN BY | Spartan Motors USA, Inc. 603 Earthway Blvd Bristol, N 46507 | | TITLE | | | | | |
| | RELEASE FOR PRODUCTION | | | | | 515140 | RLC | JYD | SCHEMATIC FREIGHTLINER MT45 | | | | | | |
| REV. | REVISIONS | | | | | AUTH | DATE | BY | CHECKED BY | APPROVED BY | ENGINEER | DATE | CAGE CODE | DWG NUMBER | |
| | | | | | | | | | RLC | | 02/17/17 | 36MV0 | 58232644 | A | |

THE INFORMATION CONTAINED IN THIS DRAWING IS THE SOLE PROPERTY OF SPARTAN MOTORS USA, INC. ANY REPRODUCTION IN PART OR AS A WHOLE WITHOUT THE WRITTEN PERMISSION OF SPARTAN MOTORS IS PROHIBITED. DOCUMENT IS ELECTRONICALLY CONTROLLED. VERIFY REV PRIOR TO USE.

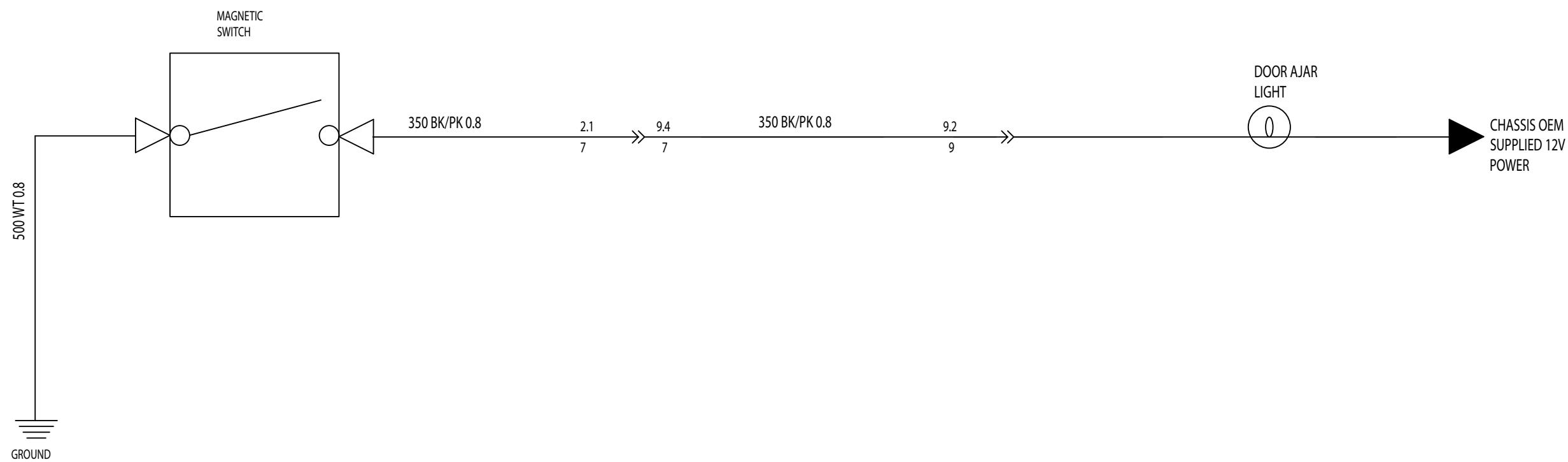

| LEGEND | |
|--------|---------------------|
| | HOT AT ALL TIMES |
| | HOT IN RUN OR START |
| | HOT IN ACC OR RUN |

PAGE 12 OF 12

| | | | | | | | | | | | | | |
|-------------------------------|-----------|--|--|--------|------|----|------------|-------------|-----------------|--------------------------|-------------------------------------------------------------------|-------------------------------------------------|-------------------------------|
| RELEASE FOR PRODUCTION | | | | 515140 | | | | | ENGINEER --- | DRAWN BY JYD | Spartan Motors USA, Inc. 603 Earthway Blvd Bristol, N 46507 | TITLE SCHEMATIC FREIGHTLINER MT45 | |
| REV. | REVISIONS | | | AUTH | DATE | BY | CHECKED BY | APPROVED BY | RLC | CHECKED BY RLC | DATE 02/17/17 | CAGE CODE 36MV0 | DWG NUMBER 58232644 |

THE INFORMATION CONTAINED IN THIS DRAWING IS THE SOLE PROPERTY OF SPARTAN MOTORS USA, INC. ANY REPRODUCTION IN PART OR AS A WHOLE WITHOUT THE WRITTEN PERMISSION OF SPARTAN MOTORS IS PROHIBITED. DOCUMENT IS ELECTRONICALLY CONTROLLED. VERIFY REV PRIOR TO USE.

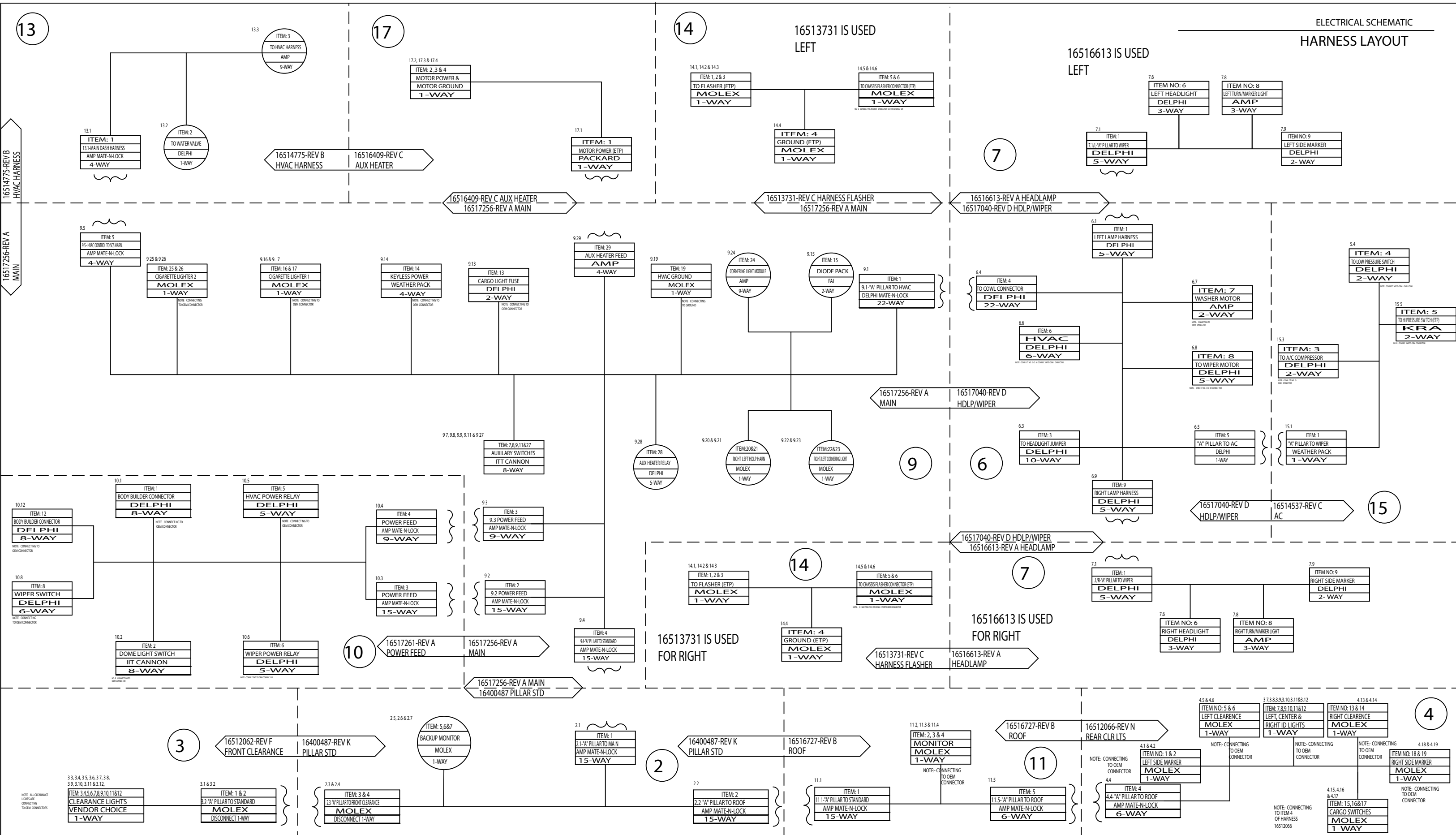

| | | | | | |
|------------|-----|-------------|----------|-----------------------------------------------------------------|-------------------------------------|
| ENGINEER | --- | DRAWN BY | JYD | TITLE | HARNESS LAYOUT FREIGHTLINER MT45 |
| CHECKED BY | RLC | DATE | 02/15/17 | CAGE CODE | 36MV0 |
| ECN-# | | DATE | | DWG NUMBER | 58232644 |
| AUTH | | BY | | DOCUMENT IS ELECTRONICALLY CONTROLLED. VERIFY REV PRIOR TO USE. | |
| DATE | | CHECKED BY | | | |
| BY | | APPROVED BY | | | |

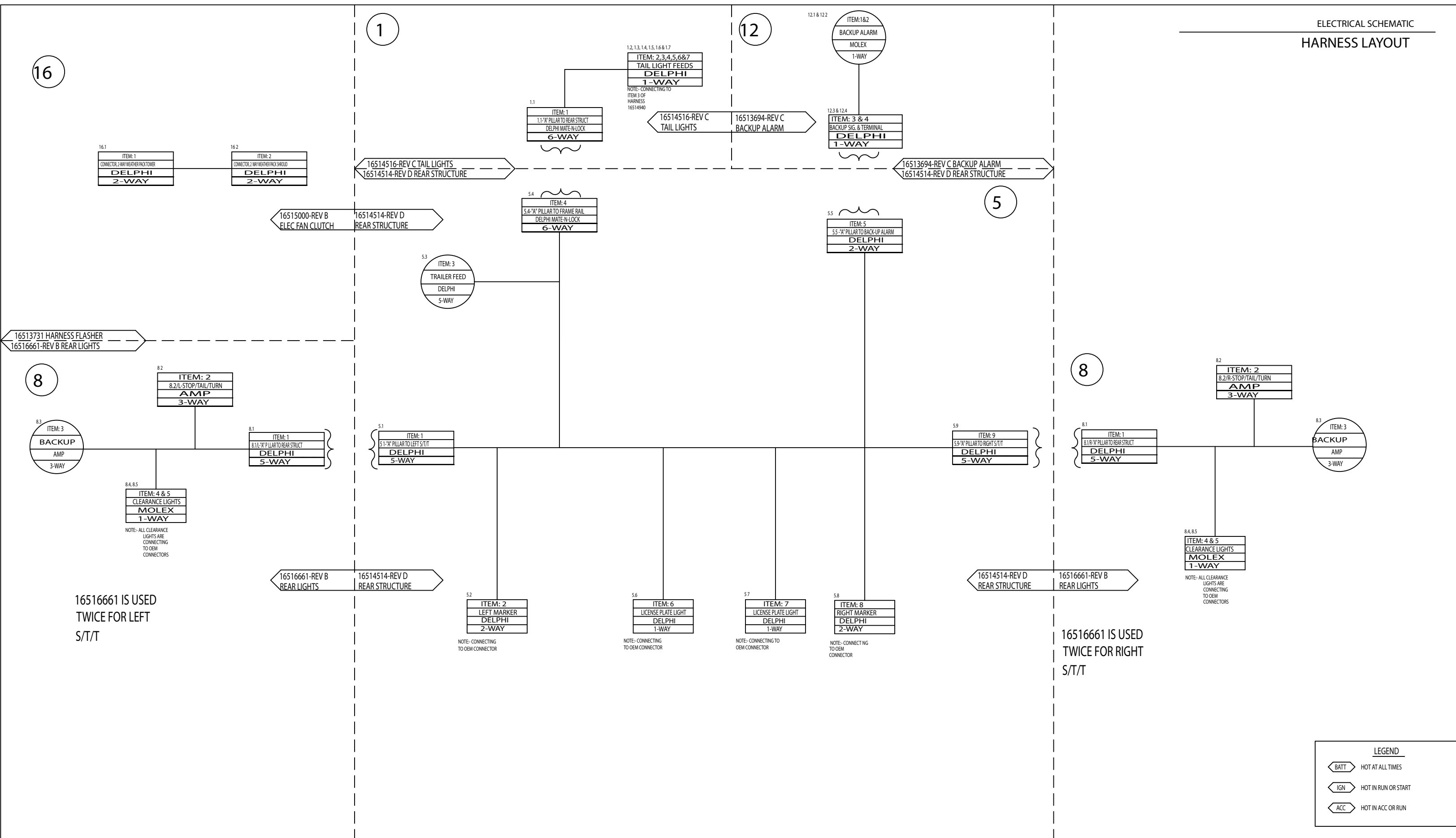

16

1

12

5

8

8

LEGEND

| | |
|------|---------------------|
| BATT | HOT AT ALL TIMES |
| IGN | HOT IN RUN OR START |
| ACC | HOT IN ACC OR RUN |

16516661 IS USED TWICE FOR LEFT S/T/T

16516661 IS USED TWICE FOR RIGHT S/T/T

PAGE 3 OF 3

| | | |
|-----|-----------------|-----------|
| REV | INITIAL RELEASE | REVISIONS |
|-----|-----------------|-----------|

| | | | | | | |
|-------|------|----|------------|-------------|------------|----------|
| ECN-# | DATE | BY | CHECKED BY | APPROVED BY | ENGINEER | DRAWN BY |
| | | | RLC | RLC | | JYD |
| | | | | | CHECKED BY | DATE |
| | | | | | RLC | 02/15/17 |

| | |
|-------------|-------------------------------------|
| TITLE | HARNESS LAYOUT FREIGHTLINER MT45 |
| CAGE CODE | 36MV0 |
| DWG. NUMBER | 58232644 |
| REV | A |

DOCUMENT IS ELECTRONICALLY CONTROLLED. VERIFY REV PRIOR TO USE.